

# Table of Contents

---

<b>Inhaltsverzeichnis</b>		<b>Metal housed Switches</b>	<b>50</b>
Overview	2	Metal housed	
How we are organized	3	V9N	51
Looking for a specialized switching solution?	4	4BR	55
Burgess is the leading global brand for industrial switches	5	<b>Positive-action Switches</b>	<b>58</b>
Switches in General Industry	6	Miniature	
Switches for locking mechanisms	6	BVM3	59
Terminology: Snap-action switches	7	KB5	62
Snap-action Microswitches	13	<b>Forced break Switches</b>	<b>65</b>
Auto Power-Off	15	Forced break	
Coil spring mechanism Microswitch	16	XP	66
Ultraminiature		XT	69
F1	17	<b>Auto Power-Off</b>	<b>71</b>
F4	20	Auto Power-Off	
F5	23	TIPPMATIC® Auto Power-Off	72
F1NS	26	TIPPMATIC® Timer	73
L16	29	TIPPMATIC® iF	74
FK4	32	TIPPMATIC® Plus	75
<b>Long overtravel Microswitches</b>	<b>35</b>	TIPPMATIC® iPlus	76
Subminiature		TIPPMATIC® Auto Power-Off Series	77
V4L	36	TIPPMATIC® Timer	78
<b>Sealed Microswitch</b>	<b>40</b>	TIPPMATIC® iF	79
Miniature sealed		TIPPMATIC® iFD Double Disconnect	80
V3NS	41	<b>Table of preferred products</b>	<b>81</b>
V3S	44		
<b>Precision Switches</b>	<b>47</b>		
Standard			
3BR	48		

# Overview

---

**The Johnson Electric Group is one of the world's largest providers of motion subsystems and motion components for automotive, medical and industrial applications.**

---

Over the years, we have shipped billions of motors to more than thirty countries in over one hundred different applications. Johnson Electric has an annual production capacity of one billion motors and motion subsystems.

---

At the heart of Johnson Electric's success is our commitment to make our customers successful. Our customers include many of the world's leading industrial, consumer and automotive companies. We begin by understanding our customers' business needs, and the product application requirements of the end user of our customers' products. Then we design and deliver innovative motion solutions that help our customers to differentiate their products in the marketplace. Our goal is to be instrumental in the successful launch of our customers' products in their respective marketplaces.

## Our Brand Promise

### Johnson Electric delivers competitive advantage

Johnson Electric delivers differentiation and innovation through its motion products – subsystems comprising of Stepper Motors, DC Motors, AC Motors, Piezo-electric Motors, Switches, Solenoids, Flexi Circuits, Motion Control, Precision Plastics and Precision Gears.

### Johnson Electric is the most reliable partner

Johnson Electric is responsive and flexible; and has the financial stability and organizational integrity to meet all of our commitments and to support our customers' success. Product reliability and assurance of supply are our commitment.

### Johnson Electric is «The Safe Choice»

- Financial strength and long standing supplier relationships.
- Unmatched assurance of supply.
- Rigorous supply chain management and complete integrity in compliance with standards.
- Unsurpassed on-time delivery.
- Global logistics support 24/7.
- Collaborative design and project management process.
- Product life cycle support from creation to end-of-life.

Our business growth hinges with leading «branded» goods producers to deliver differentiation and innovation through our motion products. The core platform for delivering these solutions is a highly developed production base and focused customer support teams throughout the world. This combines scale advantages in production and procurement with skilled and dedicated motion application experts.



# How we are organized

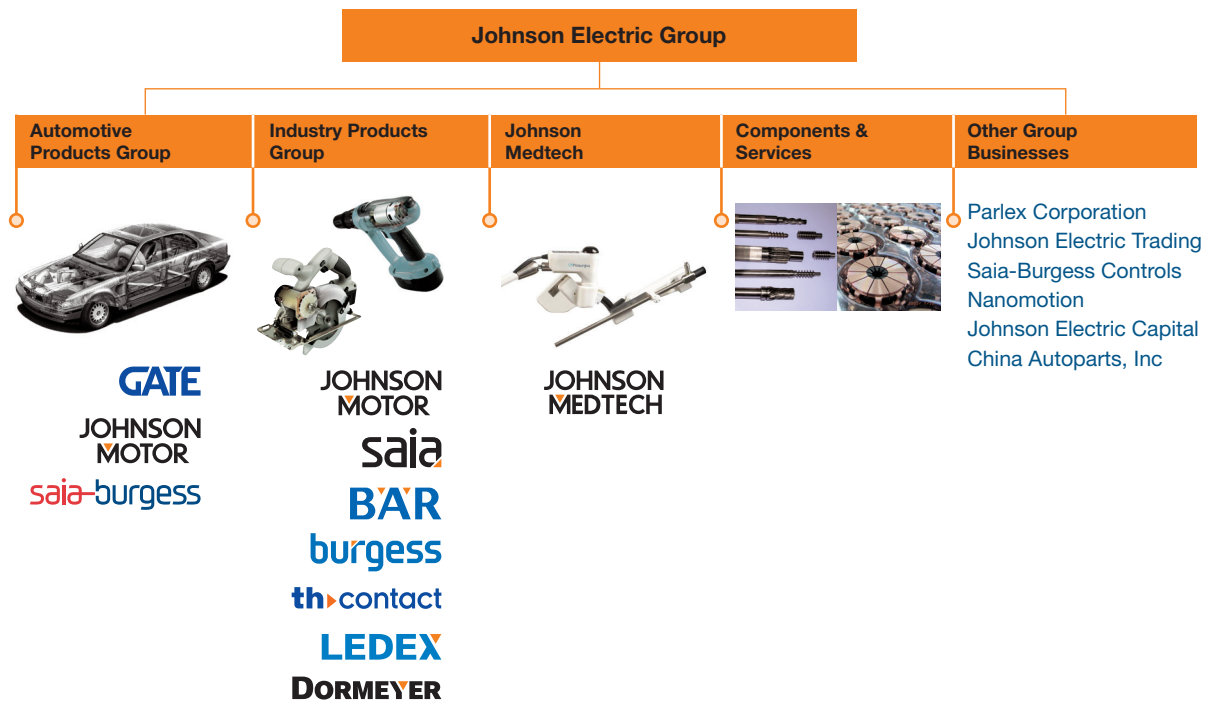

## The Group's motion systems, motors and switches businesses are managed through three operating divisions: Automotive Products Group, Industry Products Group and Johnson Medtech.

The Automotive Products Group (APG) is focused on providing customized motion solutions for all major automotive applications. APG goes to market under three product brands: Saia-Burgess for custom actuators; GATE for engine cooling fan modules; and Johnson Motor for DC motors and brushless DC motors.

The Industry Products Group (IPG) provides motion products and solutions for various commercial and industrial application sectors, including home appliances, power tools, business equipment, personal care products, medical equipment, building automation, security, audio-visual and other industrial products. IPG goes to market under seven product brands: Johnson Motor for DC motors, AC motors and BLDC motors; Saia Motor for stepper motors and synchronous motors; Ledex and Dormeyer for solenoids; and Saia, Bär, Burgess, th-contact brands for switches.

Johnson Medtech is an ISO13485 certified designer and manufacturer of motion related products for the medical device industry. The focus of Johnson Medtech is

primarily in subsystem for medication delivery systems, surgical robotics and image guided surgery.

Supporting these three business units is the Components & Services division which produces metal and plastic parts, tooling and production equipment for the Group. Johnson Electric is a highly vertically integrated business that manufactures an exceptionally wide range of components that form the basis for its final products. We make magnets, bearings, shafts, housings, laminations, commutators and die cast parts. We also build tools, assembly fixtures, plastic molds as well as armature winding and other production machines.

Supporting our customers worldwide are sixteen R&D centres located in Hong Kong (China), Shenzhen (China), Shanghai (China), Nagano (Japan), Yokneam (Israel), Asti (Italy), Murten (Switzerland), Halver (Germany), Dresden (Germany), Oldenburg (Germany), Isle of Wright (Parlex), San Jose (USA), Methuen (USA), Vandalia (USA), Springfield (USA) and Plymouth (USA).

The Group also includes a number of complementary subsidiary companies. These include an innovative provider of flexible printed circuits and interconnect solutions; a successful niche player in the programmable controls industry; and a rapidly growing China auto parts business.

# Looking for a specialized switching solution?

## Look no further:

In addition to the wide range of standard products shown in Johnson Electric catalogues, we will be happy to work with you to meet your system needs. If your application requires more than a standard product solution, please consider us early in your design process. Our product development team will be happy to discuss your specification, whether you need a special value-added assembly or a complete system. We specialize in developing solutions for medium and high-volume applications.

The images shown give some examples of our capabilities.

### Building Automation & Security



### Subsystems

#### Home Appliances, White Goods, Floor Care

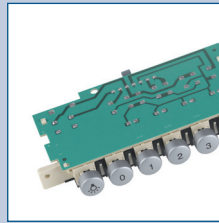

#### Business Machines, Leisure & Fitness

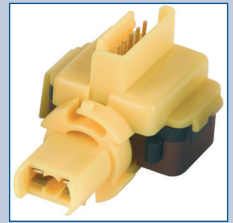

#### Transportation

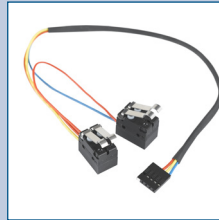

#### Industrial Equipment & Automation



### Value Added Solutions

#### Power & Garden Tools



#### Healthcare & Medical Equipment



### Products

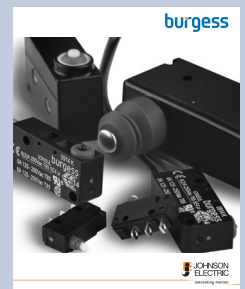
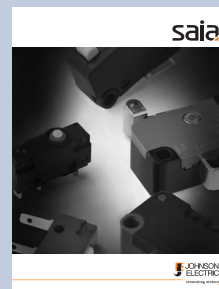

# Burgess is the leading global brand for industrial switches

**Burgess designs have defined industry standards. If you need a specific solution for your switching needs, call us to set your own standard.**

A pioneer of snap-action technology, the Burgess brand stands for innovative, robust solutions for industrial switch requirements.

## Wide range

Snap-action switches have to fulfill a wide variety of functions. The standard Burgess range ensures there will be a switch for your needs, with one of the broadest product portfolios around. From ultraminiature to metal-housed basic types, we are sure to have the type appropriate to your application, whether it is signal or power switching, high or low force actuation.

## Environmental protection

The sealed switch is a Burgess speciality. In demanding environments – wet, humid or dusty – even the most sensitive signal can be switched reliably with IP67 rated products. Our robust metal-housed switches offer impact resistance outside whilst switching with precision inside.

## Uncompromising reliability

With many UL, CSA and ENEC approvals, the performance of Burgess products is globally recognized. For safety-related applications, such as machine maintenance systems, positive-action mechanisms ensure a physical break in the circuit.

## Precision actuation

Snap-action switches offer high levels of repeat accuracy and switch virtually independently of actuation speed and force. This is the mechanism of choice for pressure sensing, timing and position indicating applications.

## Minimum size

Our F5 range demonstrates our capability to switch relatively high current from a small size envelope – 5A 250 VAC from a switch less than 13 mm long.

## Typical Burgess switch applications

- Circuit breakers
- Special purpose vehicles
- Vending machines





# Switches in General Industry

Switches can be found in a wide variety of applications:

## Burgess switches for special purpose vehicles

Switches used in special purpose vehicle applications must have:

- high levels of environmental protection
- the ability to handle high DC inrush currents
- reliability throughout the life of the product

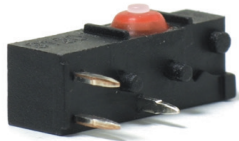

## Burgess switches for circuit breakers

Circuit breaker applications demand:

- dependability and reliability
- a high degree of shock resistance in the mechanism
- the ability to carry high currents and voltages

## Burgess switches for vending machines

Switches used in vending machines must:

- work reliably, time after time
- have appropriate environmental protection to resist dust and moisture



# Switches for locking mechanisms

Switches are found in numerous applications that require a locking device. Whether it is a medical application, an office automation application or a door lock, switches provide an effective, cost-efficient locking mechanism.



## Security Applications

- Hotel room door lock
- Hotel safe lock
- Prison door lock
- Fire safety door opening lock
- Garage door safety lock

## Office Automation

- Disk drive door lock
- Personal computer chassis lock
- Docking station lock
- Locks to hold peripherals in place
- Tape library index lock

## Medical

- Sterilizer lock
- Centrifuge lock
- Blood analysis machine lock

## Industrial

- Overhead door lock
- Fire safety door lock
- Commercial laundry locks

# Terminology: Snap-action switches

## Positions – forces – movements

Free position	Position of the actuator, without any influence from an external force.
Operating position	Position of the actuator when contact changeover takes place.
Total travel position	Position of the actuator at the end of the allowed travel.
Release position	Position of the actuator when the switch mechanism resets.
Actuating force	The force required to move the actuator from the free position to the operating position.
Release force	The value to which the applied force must be reduced to allow the mechanism to reset after operation.
Force differential	Difference between actuating force and release force.
Pre-travel	Movement of the switch actuator between free and operating position.
Over-travel	Movement of the switch actuator beyond the operating position.
Total travel	The sum of pre-travel and over-travel.
Movement differential	Distance between operating position and release position.
Release travel	Movement of the switch actuator between release and total travel position.
Post release travel	Movement of the switch actuator between release and free position.

## Contact force – movement – diagram

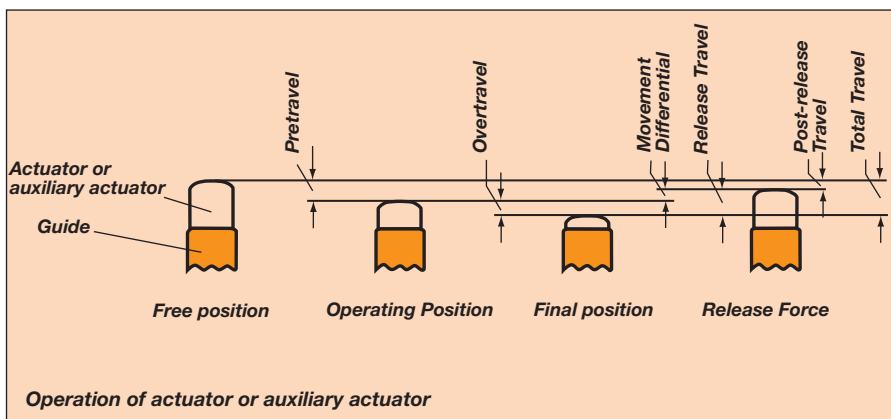

## Actuating force – movement – diagram

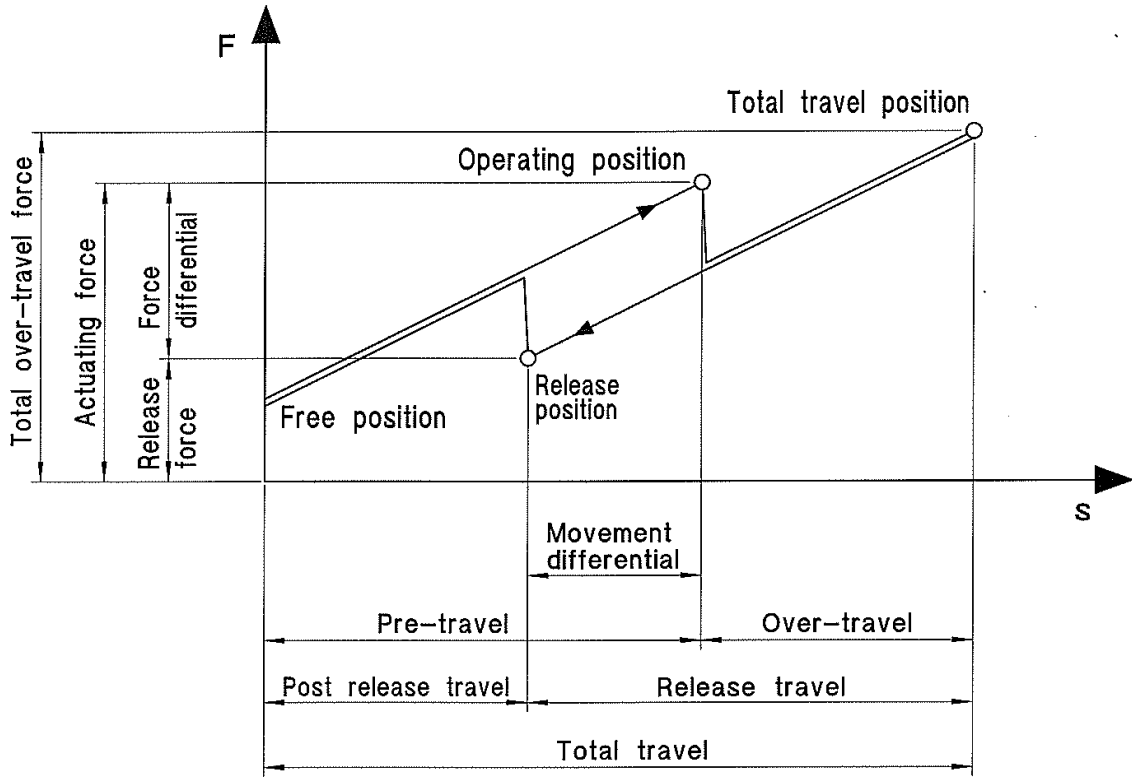

## Contact force – movement – diagram

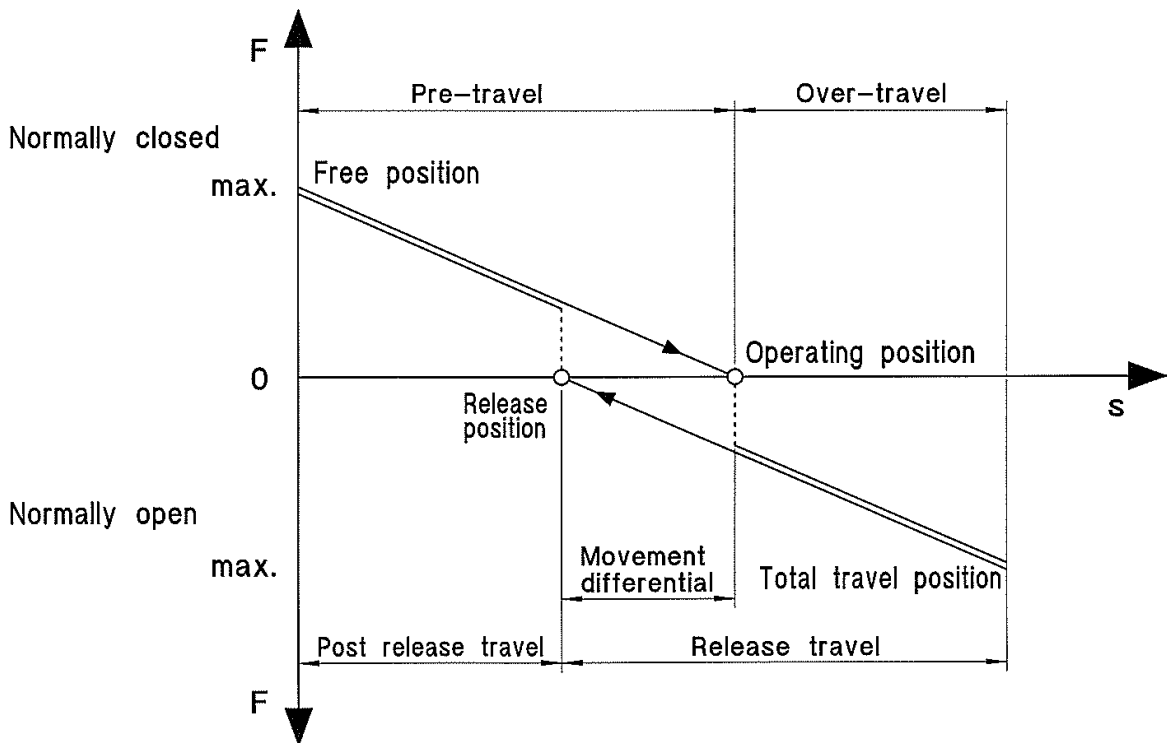



## Switch Technology

**Clearance Distance** – the distance in air between current carrying parts of opposite polarity or between any current carrying part and an earthed-(grounded) metal plate to which the switch is attached.

**Creepage Distance** – the path along the surface of insulating material between current carrying parts of opposite polarity or between any current carrying part and an earthed (grounded) metal plate to which the switch is attached.

**Insulation Resistance** – resistance as measured between the normally closed terminals, or between all terminals connected together and a metal plate to which the switch is mounted. In dry conditions the value would be expected to be greater than 5Mh.

**Single Throw** – a switch which provided an ON-OFF or OFF-ON function but does not change over from one conductor to another. Such switches are usually referred to as being «normally-closed only» or «normally-open only».

**Switching Cycle** – one complete switching operating from free position into overtravel and back through release position to free position.

**Switch Resistance** – a total resistance offered by a switch in a circuit, as measured from terminal through mating contacts, to terminal.

**Transit Time** – the time taken by the moving contact in a snap-action mechanism to move from one stable position to another.

## Electrical Ratings

**Electrical ratings given in the catalog are ratings according to UL1054, CSA22.55 or IEC61058-1.**

Where these are not available, a general rating is given based upon in-house laboratory testing.

The ratings tables should be considered as safe working maximums for most applications. However, switch performance is influenced by a variety of factors, including:

- Frequency of operation
- Type of load
- Amount of travel used
- Temperature
- Humidity

Please do not hesitate to contact Burgess about your specific application.

## Approvals



CSA mark. Switch meets CSA's safety standards



UL Recognized Component Mark for Canada and the United States



ENEC Mark. Switch fulfills European EN standards. The two digit number indicates which certification body has issued the ENEC Certificate



**CQC Approval (China) is available for certain switches**

## Switch Life

**a. Electrical Life** – the electrical life data contained in this catalog is based on laboratory controlled tests. In practice, frequency and speed of operation, type of load, suppression, actuator travel used, ambient humidity and temperature and other environmental conditions can have a major effect on switch life.

Individual assessments for specific applications are possible and can be undertaken by Burgess on request. Please ask Burgess if you would like an assessment for your specific application.

**b. Mechanical Life** – the figures quoted relate to the number of switching cycles made without an electrical load.

## Switch Drawings

All drawings in this catalogue are third angle projection. All dimensions in this catalogue are nominal, except where specifically shown.

## Application Technology

### Shock and Vibration

If switches are likely to be subjected to shock or vibration, select models with the highest available actuating force. Burgess switches feature low mass mechanisms which are inherently resistant to shock and vibration.

If possible, the switches should be mounted so that the line of acceleration is at right angles to the travel of the plunger. The maximum available overtravel should be used.

### Direct Current

Direct current (DC) ratings where shown should not be exceeded if destructive arcing and contact welding are to be avoided.

Some form of arc suppression is recommended when switches are used in DC circuits containing inductive devices wired in series with the switch and the supply.

### Lamp Loads

Because of the very high inrush currents associated with incandescent lamps, applications should be subject to individual assessment.

### Capacitive Loads (including fluorescent lamps)

These can generate very high peak currents which can cause contact welding. Applications should be subject to individual assessment.

### Inductive Loads

The general ratings tables included in this catalog provide data for switches used to control inductive circuits at a power factor of 0.5 (EN 0.6; UL 0,7 means HP-Rating 0,5).

## Contact Materials

Silver and silver alloys are the primary contact materials used in Burgess switches.

The ratings tables shown refer to switches with silver/silver alloy contacts.

Gold contacts should be specified when switches are to be used in low voltage control or logic circuits, especially when long periods of inactivity are expected or when atmospheres with a high sulphur content may be encountered. Gold contacts are generally available in two forms; gold plated silver alloy contacts, which can also be used at higher currents or gold alloy cross-point contacts, which are only suitable for switching low currents.

**Please ask Burgess if you would like an assessment for your specific application.**

## Switch Actuation

### Direct Operation

Actuating plungers should be operated in the direction of their axis. Where this is not possible the use of actuating levers is recommended. For direct actuation the attack angle should not exceed 30°\*.

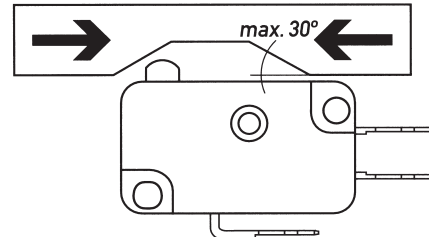

*Actuation by sliding cams.*

\* For ranges V3NS, XP, XT ask Burgess

### Actuating Levers

Various lever types are available for use with Burgess switches. They are generally stainless steel. If roller or cam-follower levers are approached in the reverse direction, care must be taken to ensure that the angle of approach is small enough not to jam the lever.

### Actuation by Cams

Cam-follower levers are particularly well suited for use with plastic actuating cams.

Abrupt actuation or release of switch actuators shortens the life of the switches.

For this reason cam should preferably provide a continuous movement. Ideally they should be of cycloidal form.

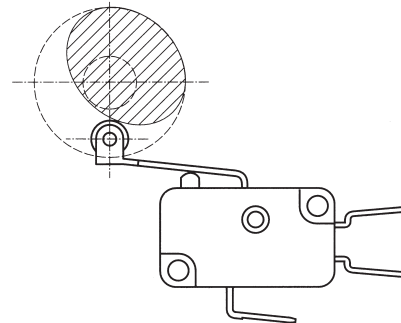

*Long roller lever with continuous actuation*

---

## Environmental Protection

### Protection Classifications

The protection classes of Burgess switches are in accordance with IEC 529 and are covered by just four codes.

#### IP40

Adequate protection against solids such as probing fingers and small wires >1mm. Liquids however can gain access and, unless externally protected, the switches should be mounted in dry or well-sheltered positions.

#### IP5K4

Good protection against solid foreign bodies, including dust and water splashing against the enclosure from any direction.

Switches may be used out of doors if sheltered from the worst of the elements or on factory machines subjected to normal washing down procedures.

#### IP65

Complete protection against solids, including dust, and against low pressure jets of water from all directions.

#### IP6K7

Complete protection against solids including dust and against immersion in water at a specific pressure for a specified time.

We reserve this code for switches which are factory sealed and tested. Switches should not be immersed in any liquid.

**\* International IK code indicates protection against mechanical impact regarding to EN 50102.**

### Working Temperatures

For details of the working temperatures applicable to individual types, refer to the appropriate specification sheet. Special versions suitable for temperatures outside these ranges may be possible. Please contact us for information.

**All quoted temperatures assume stable operation. They do not imply an ability to withstand excessive cycling within the range.**

## Health & Safety

Burgess has ensured, so far as it is reasonably practicable, that their products are as described in this catalog or in other current company publications, or as specified on Burgess

installation drawings. They have been so designed and constructed as to be safe and without risk to health when installed by suitably qualified personnel in accordance with relevant legislation, codes of practice, regulations (including IEE Wiring Regulations), the installation recommendations offered by the company and the accepted rules of the art. Their usage should be confined within the ratings limitations and parameters of application indicated in this catalog and elsewhere.

Please contact us should you need additional information or guidance.

## Service Recommendations

### Maintenance

Burgess switches are not user-maintainable but they should be kept in a reasonably clean, paint-free condition, especially in the actuator area. Regular checks should be made on mounting security and on the actuating medium to switch actuator relationship.

Lubrication or the use of aqueous or chemical cleaning fluids is not recommended.

## Installation Recommendations

The following notes are intended merely to stress the most important and general aspects of good switch installation procedure and to provide some helpful additional information. Safety Consideration

Installation should only be carried out by competent personnel.

### Switch Positioning and Operation

Pre-loading of the switch actuator must be avoided. The actuating medium must be able to operate the switch through the operating position into overtravel and then to retract far enough to allow the switch to regain its free position.

Burgess recommends that the actuating medium should drive the switch into at least 50% of the available overtravel.

All ratings tables shown in this catalog are based on the use of all the available overtravel.

---

## Mounting

Side mounting switches should be mounted on smooth, firm, flat surfaces using the recommended screw size. Avoid over tightening the screws. For added security, they should be locked using epoxy resin. Do not attempt to enlarge switch mounting holes and avoid over stressing the switch. Use insulating material between the switch and metallic plates to increase clearance on switches with open terminals.

## Connections

When soldering, overheating of the switch insulation must be avoided. In certain circumstances, it may be advisable to use a heat shunt. For optimum mechanical strength, the conductor should be wrapped round the tip of the terminal taking care to avoid loose strands of wire.

The soldering iron tip should be applied to the end of the terminal while simultaneously applying solder. Remove the iron as soon as the solder has wetted the conductor and terminal end. A-soldering iron tip temperature of 350°C (260°C/5 seconds for PCB Terminals) applied for a maximum of 2-3 seconds should be adequate.

**For lead-free solder, is usually needed an iron tip temperature 15% higher.**

## Installation Recommendations (EN 61058-1)

Mounting Holes and Screw sizes				Mounting Screw Torque	
Normal hole Diameter		Metric Thread	Unified	For guidance when using	
(mm)	(in)	Screw	Screw	mild steel screws:	
2.2/2.3	0.067/0.091	M2	#2	M2 or #2 screws	0.15Nm
3.1/3.2	0.122/0.126	M3	#4	M3 or #4 screws	0.5Nm
3.6/3.7	0.142/0.146	M3.5	#6	M3.5 or #6 screws	0.8Nm
5.1/5.2	0.201/0.205	M5	#10	M5 or #10 screws	3.0Nm

# Snap-action Microswitches

## Ultraminiature



Type	F1	F4	F5	F1NS	L16
Characteristics	<ul style="list-style-type: none"> <li>small size</li> <li>high current</li> <li>long mechanical and electrical life</li> <li>PCB mounting</li> </ul>	<ul style="list-style-type: none"> <li>small size</li> <li>long mechanical and electrical life</li> <li>solder terminals</li> <li>solder terminals</li> </ul>	<ul style="list-style-type: none"> <li>small size</li> <li>long mechanical and electrical life</li> <li>PCB mounting</li> </ul>	<ul style="list-style-type: none"> <li>small size</li> <li>PCB mounting</li> <li>sealed IP54 (option)</li> </ul>	<ul style="list-style-type: none"> <li>small size</li> <li>sealed (IP6K7)</li> <li>PCB mounting</li> </ul>
Rating	250 VAC, 5 A	250 VAC, 5 A	250 VAC, 5 A	up to 250 VAC, 1 A	12–30 VDC, 1–300 mA
Dimensions (mm)	16 × 6 × 6.5	12.8 × 10 × 5	12.8 × 7 × 5	14.6 × 6.5 × 6	14.7 × 9 × 5.4
Actuator	<ul style="list-style-type: none"> <li>plunger</li> <li>plain lever</li> <li>simulated roller lever/cam follower</li> </ul>	<ul style="list-style-type: none"> <li>plunger</li> <li>plain lever</li> <li>simulated roller lever/cam follower</li> </ul>	<ul style="list-style-type: none"> <li>plunger</li> <li>plain lever</li> <li>simulated roller lever/cam follower</li> </ul>	<ul style="list-style-type: none"> <li>plunger</li> <li>plain lever</li> <li>simulated roller lever/cam follower</li> </ul>	<ul style="list-style-type: none"> <li>plunger</li> <li>plain lever</li> <li>cam follower</li> </ul>
Approvals	UL, CSA	UL, CSA	UL, CSA	none	Automotive standard
Page	16	19	22	25	28



## Subminiature

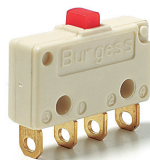

## Miniature sealed



Type	FK4	V4L	V3NS	V3S
Characteristics	<ul style="list-style-type: none"> <li>double break switching</li> <li>long mechanical and electrical life</li> <li>solder</li> </ul>	<ul style="list-style-type: none"> <li>long overtravel of 2.2 mm minimum</li> <li>sealed to IP6K7 option</li> <li>pre-wired option</li> <li>solder terminals</li> <li>compliant to glow wire test IEC 60335-1, 4. ed. as optional item</li> </ul>	<ul style="list-style-type: none"> <li>sealed (IP67)</li> <li>pre-wired option</li> <li>faston terminals</li> <li>robust construction</li> <li>compliant to glow wire requirements IEC 60335</li> </ul>	<ul style="list-style-type: none"> <li>sealed (IP67)</li> <li>pre-wired</li> <li>robust construction</li> </ul>
Rating	250 VAC, 5 A	250 VAC, 5 A	250 VAC, 6 A	250 VAC, 5 A
Dimensions (mm)	18 × 8 × 5	20 × 11 × 6.4	33 × 10.4 × 15.9	32 × 24 × 10
Actuator	<ul style="list-style-type: none"> <li>plunger</li> <li>plain lever</li> <li>simulated roller lever/cam follower</li> </ul>	<ul style="list-style-type: none"> <li>plunger</li> <li>plain lever</li> <li>ice break lever</li> </ul>	<ul style="list-style-type: none"> <li>plunger</li> <li>plain lever</li> <li>roller lever</li> <li>cam follower lever</li> </ul>	<ul style="list-style-type: none"> <li>plunger</li> <li>plain lever</li> <li>roller lever</li> </ul>
Approvals	UL, CSA	ENEC, UL, CSA	UL, CSA, ENEC	UL, CSA, ENEC
Page	31	35	40	43

# Snap-action Microswitches

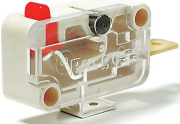
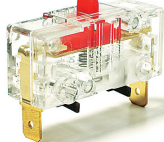
	Standard	Metal housed	
			
Type	<b>3BR</b>	<b>V9N</b>	<b>4BR</b>
Characteristics	<ul style="list-style-type: none"> <li>choice of IP54 or IP67 sealed versions</li> <li>precise movements</li> <li>screw terminals</li> <li>pre-wired option</li> <li>long overtravel</li> </ul>	<ul style="list-style-type: none"> <li>sealed (IP67)</li> <li>metal housed</li> <li>screw terminals</li> <li>pre-wired option</li> </ul>	<ul style="list-style-type: none"> <li>choice of IP54 or IP67 sealed versions</li> <li>precise movements</li> <li>metal housing</li> <li>pre-wired option</li> <li>long overtravel</li> </ul>
Rating	250 VAC, 10 A max.	250 VAC, 10 A max.	125 VAC, 10 A max.
Dimensions (mm)	53.1 × 20.6 × 30.8	42 × 24.5 × 16	53.1 × 20.6 × 29.2
Actuator	<ul style="list-style-type: none"> <li>plunger</li> </ul>	<ul style="list-style-type: none"> <li>plunger</li> <li>plain levers</li> <li>reverse action levers</li> <li>roller levers</li> </ul>	<ul style="list-style-type: none"> <li>plunger</li> </ul>
Approvals	UL, CSA	UL, CSA	UL, CSA
Page	52	55	59

	Miniature	Standard	Forced break	
				
Type	<b>BVM3</b>	<b>KB5</b>	<b>XP</b>	<b>XT</b>
Characteristics	<ul style="list-style-type: none"> <li>positive-action forced break switching</li> <li>&gt; 3 mm contact gap at full travel</li> <li>internationally recognized V3 housing</li> <li>faston terminals</li> </ul>	<ul style="list-style-type: none"> <li>positive-action forced double break switching</li> <li>&gt; 3 mm contact gap at full travel</li> <li>high electrical rating</li> <li>faston terminals</li> </ul>	<ul style="list-style-type: none"> <li>double break switching</li> <li>positive-action force break option</li> <li>&gt; 3 mm contact gap at full travel option</li> <li>faston terminals</li> </ul>	<ul style="list-style-type: none"> <li>8 mm contact gap</li> <li>8 mm creepage and clearance distances</li> <li>double break contacts</li> </ul>
Rating	250 VAC, 10 A	up to 250 V, 25 A	400 VAC, 16 A	400 VAC, 16.5 A max.
Dimensions (mm)	28 × 16 × 10.5	41 × 19.5 × 15.5	30 × 32 × 12	30 × 32 × 12
Actuator	<ul style="list-style-type: none"> <li>plunger</li> <li>plain lever</li> <li>roller lever</li> </ul>	<ul style="list-style-type: none"> <li>plunger</li> <li>plain lever</li> <li>roller lever</li> </ul>	<ul style="list-style-type: none"> <li>plain plunger</li> <li>mushroom plunger</li> <li>plunger with external spring (for increased reset security)</li> </ul>	<ul style="list-style-type: none"> <li>shrouded plunger</li> <li>optional key</li> <li>plain plunger</li> </ul>
Approvals	ULS, CSA, ENEC	ULS, CSA	UL, CSA, ENEC	UL, cUL, CSA, ENEC
Page	63	66	70	73



# Auto Power-Off

## Rocker



Type **3600**

## Push button

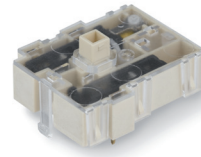

Type **3620**

Characteristics	<ul style="list-style-type: none"> <li>■ single pole on/off power switch</li> <li>■ auto power-off function embedded</li> <li>■ 4 variants:               <ul style="list-style-type: none"> <li>■ Timer</li> <li>■ iF with interface</li> <li>■ Plus with interface</li> <li>■ iPlus with interface &amp; microcontroller</li> </ul> </li> <li>■ ideal for small appliances &amp; coffee machines</li> </ul>	<ul style="list-style-type: none"> <li>■ single or double pole on/off power switch</li> <li>■ auto power-off function embedded</li> <li>■ 3 variants:               <ul style="list-style-type: none"> <li>■ Timer, single disconnect</li> <li>■ iF with interface, single disconnect</li> <li>■ iFD with interface, double disconnect</li> </ul> </li> <li>■ programmable control option</li> <li>■ ideal for appliances, coffee machines &amp; white goods</li> </ul>
Rating	250 VAC, 12 (4) A or 125 VAC, 15 A	250 VAC, 12 (4) A or 125 VAC, 15 A
Dimensions (mm)	37,2 x 17 x ~38	Tippmatic iF 25 x 40 x 13, Tippmatic iFD 44 x 32 x 12
Actuator	<ul style="list-style-type: none"> <li>■ standard rocker 25,4 x 10,7 mm</li> <li>■ customized actuators</li> </ul>	<ul style="list-style-type: none"> <li>■ plunger</li> <li>■ customized actuators</li> </ul>
Approvals	ENEC, cULus	ENEC, cULus
Page	72	77

# Coil spring mechanism Microswitch

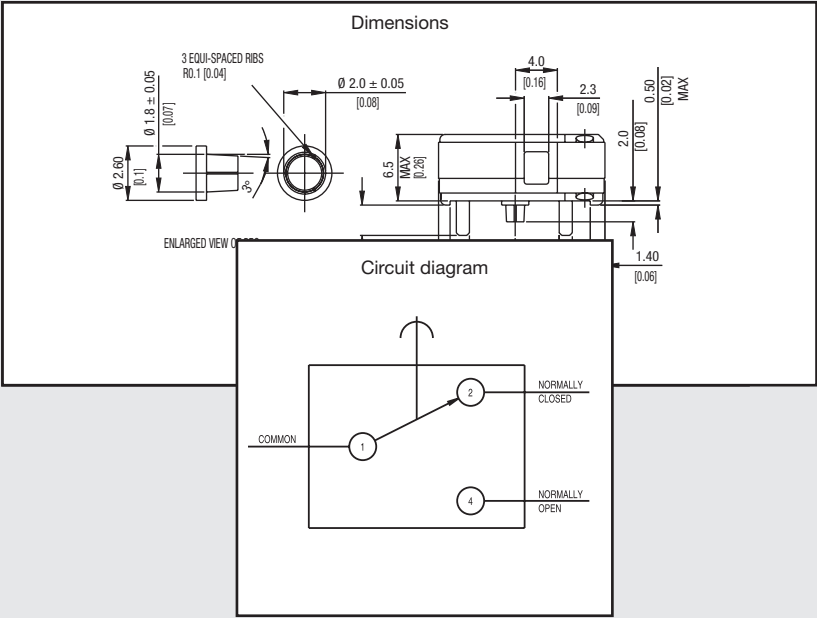
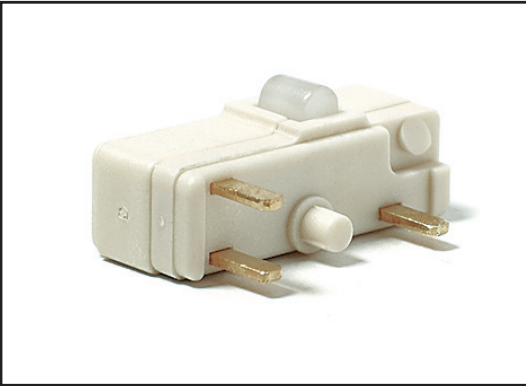

# F1

## F1

- Characteristics
- small size
  - high current
  - long mechanical and electrical life
  - PCB mounting

Rating 250 VAC, 5 A

Dimensions (mm) 16 × 6 × 6,5

- Actuator
- plunger
  - plain lever
  - simulated roller lever/cam follower

Approvals UL, CSA

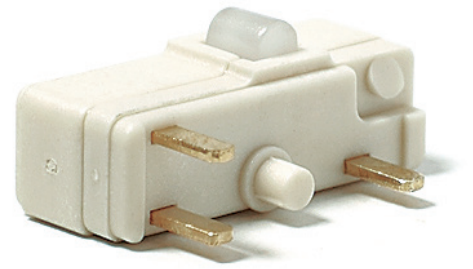

## Preferred Range

Ordering Reference	Actuating Force (N) (ozf)		Sealing	Operating pos. (mm) (in)		Terminal	Circuit	Actuator	Contacts	Electrical rating
F1T8GPUL	1,4	5,00	IP40	6,35	0,25	PCB	CO	Plunger	Gold plate	Up to 250 VAC, 5 A
F1T8Y1GPUL	0,5	1,8	IP40	8,5	0,33	PCB	CO	Lever	Gold plate	Up to 250 VAC, 5 A

## Specifications

Housing	Glass fibre reinforced flame retardant nylon
Plunger	Nylon
Mechanism	Snap-action, coil spring mechanism with stainless steel spring
Functions	Single pole change-over
Contacts	Gold plate on silver
Terminals	PCB - copper, gold-flashed
Temperature range °C	-40°C to +85°C
Mechanical life	10 <sup>6</sup> cycles minimum (impact-free actuation)
Protection	IP40 (enclosure)
Mounting	Side mount PCB with locating pin on housing
Actuators	Plain plunger, stainless steel

Circuit diagram

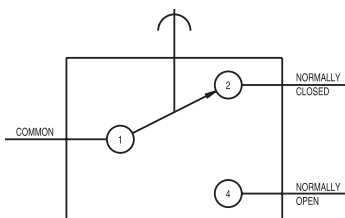

## Dimensions

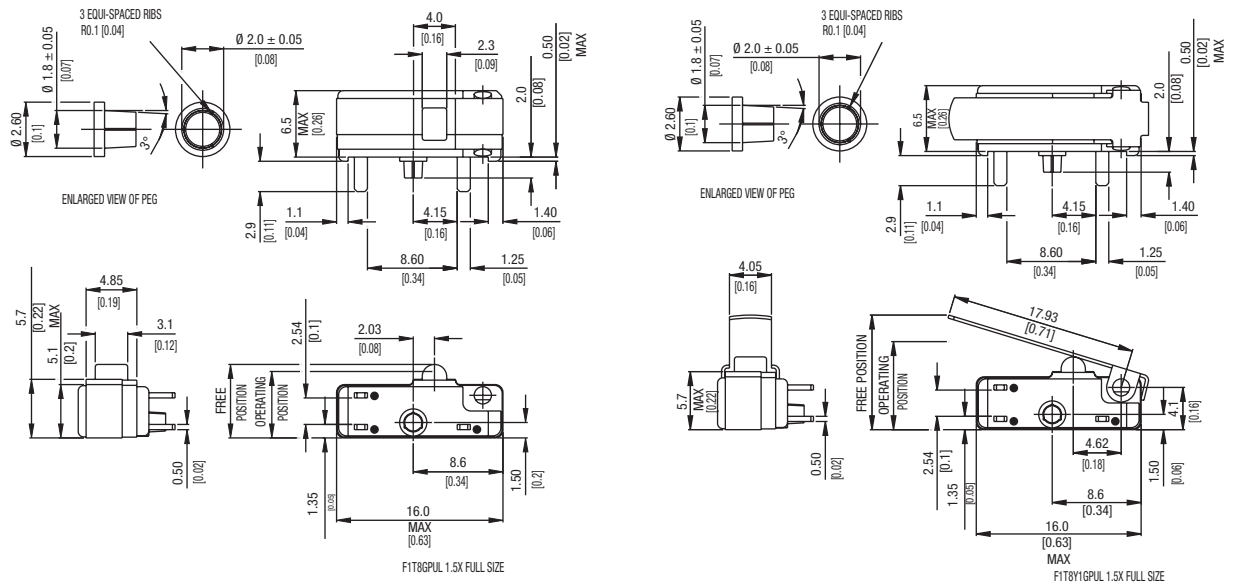

## Recommended maximum electrical ratings

Voltage (max)	Resistive load (A)	Inductive load	Approval
250 VAC	5 (0.75 pf)	5	UL 1054/CSA 22.2 No. 55 - 6,000 operations
0 - 15 VDC	5		General rating - 50,000 operations
15 - 30 VDC	3		General rating - 50,000 operations

## Operating Characteristics

Actuator	Reference	Actuating Force Maximum		Release Force Minimum		Free Position Maximum		Operating Position		Movement Differential Maximum		Over Travel	
		(N)	(ozf)	(N)	(ozf)	(mm)	(in)	(mm)	(in)	(mm)	(in)	(mm)	(in)
Plunger	F1T8GPUL	1,4	5,00	0,28	1,00	7,1	0,28	6,35 ± 0,38	0,25 ± 0,015	0,1	0,004	*	
Straight lever	F1T8Y1GPUL	0,5	1,8	0,06	0,022	11,0	0,43	8,5 ± 1,5	0,33 ± 0,06	0,5	0,02	*	

Width of lever 4.05 mm/0.16 in

\* Plunger can be depressed flush with housing. The housing should not be used as an end stop.

## Ordering Reference

Basic type	F1	Example: F1   T8   Y1   GP   UL			
Terminals	T8	PCB	1,25 × 0,5 × 2,9 long		
Actuators		No symbol, without lever			
	Y1	Plain lever 21.0 mm			
	YR1	Roller lever 16.0 mm			
Contacts Material		No symbol, Ag			
	GP	Gold plate on Ag (GP)			
Approvals	UL	UL and CSA approval			
Special Features	/□□□□	Burgess specialise in customer specific solutions. Additional product variants are available or can be provided. If your requirements cannot be satisfied from the options listed, please contact us.			

# F4

## F4

Characteristics

- small size
- long mechanical and electrical life
- solder terminals

Rating 250 VAC, 5 A

Dimensions (mm) 12.8 × 10 × 5

Actuator

- plunger
- plain lever
- simulated roller lever/cam follower

Approvals UL, CSA



## Preferred Range

Ordering Reference	Actuating Force (N) (ozf)		Sealing	Operating pos. (mm) (in)		Terminal	Circuit	Actuator	Contacts	Electrical rating
F4T7UL	1.4	5.00	IP40	8.1	0.32	Solder	CO	Plunger	Ag	Up to 250 VAC, 5 A
F4T7GPUL	1.4	5.00	IP40	8.1	0.32	Solder	CO	Plunger	Gold plate	Up to 250 VAC, 5 A
F4T7Y1UL	0.6	2.20	IP40	8.2	0.32	Solder	CO	Plain lever	Ag	Up to 250 VAC, 5 A
F4T7Y1GPUL	0.6	2.20	IP40	8.2	0.32	Solder	CO	Plain lever	Gold plate	Up to 250 VAC, 5 A
F4T7YCUL	0.7	2.50	IP40	10.3	0.41	Solder	CO	Simulated roller	Ag	Up to 250 VAC, 5 A
F4T7YCGPUL	0.7	2.50	IP40	10.3	0.41	Solder	CO	Simulated roller	Gold plate	Up to 250 VAC, 5 A



## Specifications

Housing	Glass fibre reinforced flame retardent nylon
Plunger	Nylon
Mechanism	Snap-action, single pole
Functions	Change-over, Normally open, Normally closed
Contacts	Fixed, Moving – Ag or Gold plate on Ag
Terminals	2.0 mm (0.08 in) faston and solder - brass, gold flashed
Temperature range °C	-40°C to +85°C
Mechanical life	10 <sup>7</sup> cycles minimum (impact free actuation)
Protection	IP 40 (enclosure)
Mounting	Side mounting
Actuators	Plain lever, simulated roller lever/cam follower, stainless steel
Accessories	Lug mounting frame, insulating sheet, spring-leaf actuator

Circuit diagram

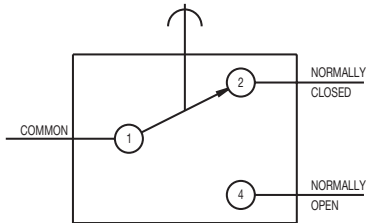

Dimensions

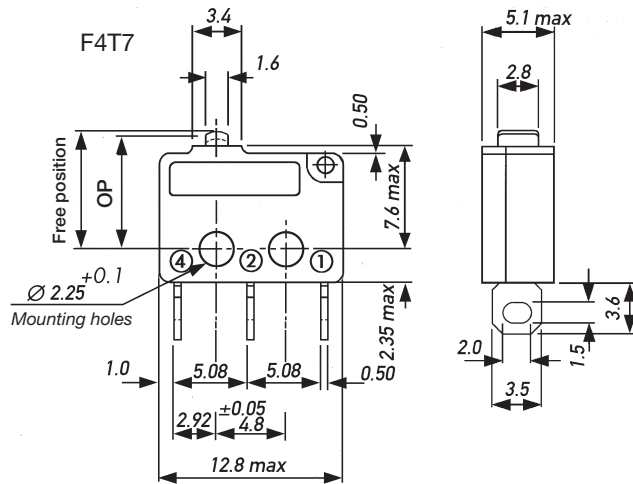

## Recommended maximum electrical ratings

Voltage (max)	Load (A)	Approval
250 VAC	5 (0.75 pf)	UL 1054/CSA 22.2 No. 55 - 6,000 operations
125 VAC	5 (0.75 pf)	UL 1054/CSA 22.2 No. 55 - 6,000 operations
0 - 15 VDC	5	General rating - 50,000 operations
15 - 30 VDC	3	General rating - 50,000 operations

## Operating Characteristics

Actuator	Reference	Actuating Force		Release Force		Free Position		Operating Position		Movement Differential		Over travel		
		Maximum (N)	(ozf)	Minimum (N)	(ozf)	Maximum (mm)	(in)	(mm)	(in)	Maximum (mm)	(in)			
Plunger	F4T7	1,4	5,00	0,25	0,90	8,8	0,35	8,1	+0.3 -0.2	0,32	+0.01 -0.008	0,13	0,005	*
Y1-Lever	F4T7Y1	0,6	2,20	0,07	0,25	10,0	0,39	8,2	+1.0 -0.7	0,32	+0.04 -0.03	0,70	0,030	*
YC-Lever	F4T7YC	0,7	2,50	0,09	0,32	12,5	0,46	10,3	+0.8 -0.55	0,41	+0.03 -0.02	0,45	0,020	*

Operating characteristics are specified from the mounting holes.

\* Plunger can be depressed flush with housing. The housing should not be used as an end stop.

## Ordering Reference

Basic type	F4	Example: F4   T7   Y1   GP   UL		
Terminals	T7	Solder	3.50 × 0.5 × 3.6 long	
Circuit		No symbol, change-over		
Actuators		No symbol, without lever		
	Y1	Plain lever 21.0 mm		
	YC	Cam follower lever 16.9 mm		
Contacts Material		No symbol, Ag		
	GP	Gold plate on Ag (GP)		
Approvals		No symbol, without approval		
	UL	UL and CSA approval		
Special Features	/□□□□	<b>Burgess specialise in customer specific solutions.</b> Additional product variants are available or can be provided. If your requirements cannot be satisfied from the options listed, please contact us.		

# F5

## F5

Characteristics	<ul style="list-style-type: none"> <li>■ small size</li> <li>■ long mechanical and electrical life</li> <li>■ PCB mounting</li> </ul>
Rating	250 VAC, 5 A
Dimensions (mm)	12.8 × 7 × 5
Actuator	<ul style="list-style-type: none"> <li>■ plunger</li> <li>■ plain lever</li> <li>■ simulated roller lever/cam follower</li> </ul>
Approvals	UL, CSA



## Preferred Range

Ordering Reference	Actuating Force (N) (ozf)		Sealing	Operating pos. (mm) (in)		Terminal	Circuit	Actuator	Contacts	Electrical rating
F5T8UL	1.4	5.00	IP40	8.75	0.34	PCB	CO	Plunger	Ag	Up to 250 VAC, 5 A
F5T8GPUL	1.4	5.00	IP40	8.75	0.34	PCB	CO	Plunger	Gold plate	Up to 250 VAC, 5 A
F5T8Y1UL	0.6	2.20	IP40	8.80	0.35	PCB	CO	Plain lever	Ag	Up to 250 VAC, 5 A
F5T8Y1GPUL	0.6	2.20	IP40	8.80	0.35	PCB	CO	Plain lever	Gold plate	Up to 250 VAC, 5 A
F5T8YCUL	0.7	2.50	IP40	10.90	0.43	PCB	CO	Simulated roller	Ag	Up to 250 VAC, 5 A
F5T8YCGPUL	0.7	2.50	IP40	10.90	0.43	PCB	CO	Simulated roller	Gold plate	Up to 250 VAC, 5 A

## Specifications

Housing	Glass fibre reinforced flame retardent nylon
Plunger	Nylon
Mechanism	Snap-action, single pole
Functions	Change-over, Normally open, Normally closed
Contacts	Fixed, Moving - Silver or Gold plate on silver
Terminals	PCB - Brass, gold flashed
Temperature range °C	-40°C to +85°C
Mechanical life	10 <sup>7</sup> cycles minimum (impact free actuation)
Protection	IP 40 (enclosure)
Mounting	PCB
Actuators	Plain lever, simulated roller lever/cam follower, stainless steel

Circuit diagram

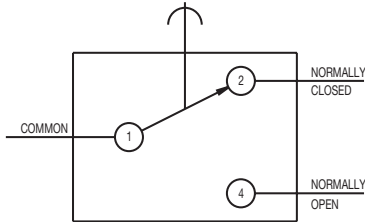

Dimensions

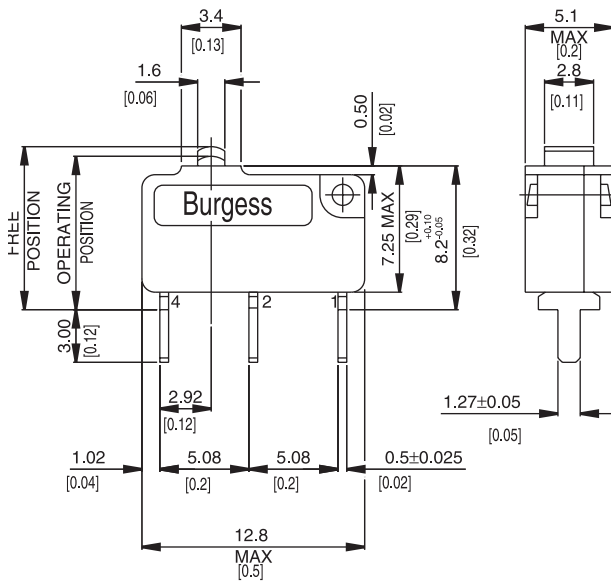

## Recommended maximum electrical ratings

Voltage (max)	Load (A)	Approval
250 VAC	5 (0.75 pf)	UL 1054/CSA 22.2 No. 55 - 6,000 operations
125 VAC	5 (0.75 pf)	UL 1054/CSA 22.2 No. 55 - 6,000 operations
0 - 15 VDC	5	General rating - 50,000 operations
15 - 30 VDC	1	General rating - 50,000 operations

## Operating Characteristics

Actuator	Reference	Actuating Force Maximum		Release Force Minimum		Free Position Maximum		Operating Position		Movement Differential Maximum		Over travel
		(N)	(ozf)	(N)	(ozf)	(mm)	(in)	(mm)	(in)	(mm)	(in)	
Plunger	F5T8	1,4	5,00	0,25	0,90	9,5	0,37	8,75 ± 0,3	0,34 ± 0,012	0,13	0,005	*
Y1-Lever	F5T8Y1	0,6	2,20	0,07	0,25	10,7	0,42	8,8 ± 1,1	0,35 ± 0,04	0,70	0,030	*
YC-Lever	F5T8YC	0,7	2,50	0,09	0,32	12,4	0,49	10,9 ± 0,85	0,43 ± 0,03	0,45	0,020	*

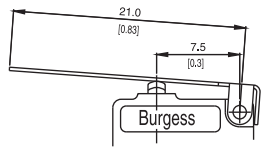
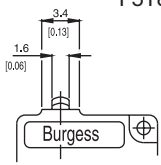

Width of lever 3.0 mm/0.12 in

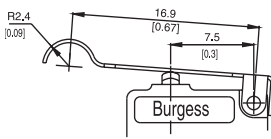

Width of lever 3.0 mm/0.12 in

Operating characteristics are specified from the terminal shoulder.

\* Plunger can be depressed flush with housing. The housing should not be used as an end stop.

## Ordering Reference

Basic type	F5	Example: F5 T8		Y1	GP	UL
Terminals	T8	PCB	1.27 × 0.5 × 3.0 long			
Circuit	No symbol, change-over					
Actuators	No symbol, without lever					
	Y1	Plain lever 21.0 mm				
	YC	Cam follower lever 16.9 mm				
Contact Material	No symbol, Ag					
	GP	Gold plate on Ag (GP)				
Approvals	No symbol, without approval					
	UL	UL and CSA approval				
Special Features	/□□□□	Burgess specialise in customer specific solutions. Additional product variants are available or can be provided. If your requirements cannot be satisfied from the options listed, please contact us.				

# F1NS

## F1NS

- Characteristics
- small size
  - low current
  - long mechanical life
  - PCB mounting
  - sealed IP54 (option)

Rating Up to 250 VAC, 1 A

Dimensions (mm) 14.6 × 6.5 × 6

- Actuator
- plunger
  - plain lever
  - simulated roller lever/cam follower

Approvals none

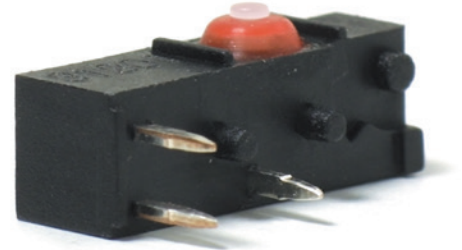

## Preferred Range

Ordering Reference	Actuating Force (N)      (ozf)		Sealing	Operating pos. (mm)	Terminal	Circuit	Actuator	Contacts	Electrical rating
F1NST8	2,0	7,2	IP5K4	5,9	PCB	CO	Plunger	Ag	250 VAC, 1 A
F1NST8A1	0,6	2,2	IP5K4	7,6	PCB	CO	Plain lever	Ag	250 VAC, 1 A
F1NST8AC	0,6	2,2	IP5K4	10,1	PCB	CO	Cam follower	Ag	250 VAC, 1 A



## Specifications

Housing	Base: PA 6.6; Cowl: Silicon; Lid: PA 6.6
Plunger	POM
Mechanism	Snap-action, coil spring mechanism with stainless steel spring. Single-pole change-over contact
Contacts	Fine silver, Gold plate on silver
Terminals	PCB - Phosphor Bronze silver plated
Temperature range °C	-40°C bis +85°C
Mechanical life	10 <sup>7</sup> cycles minimum (impact-free actuation)
Protection	Enclosure IP40 (F1N), IP54 (F1NS)
Mounting	PCB. Locating pins on housing

Circuit diagram

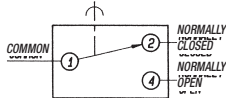

Dimensions

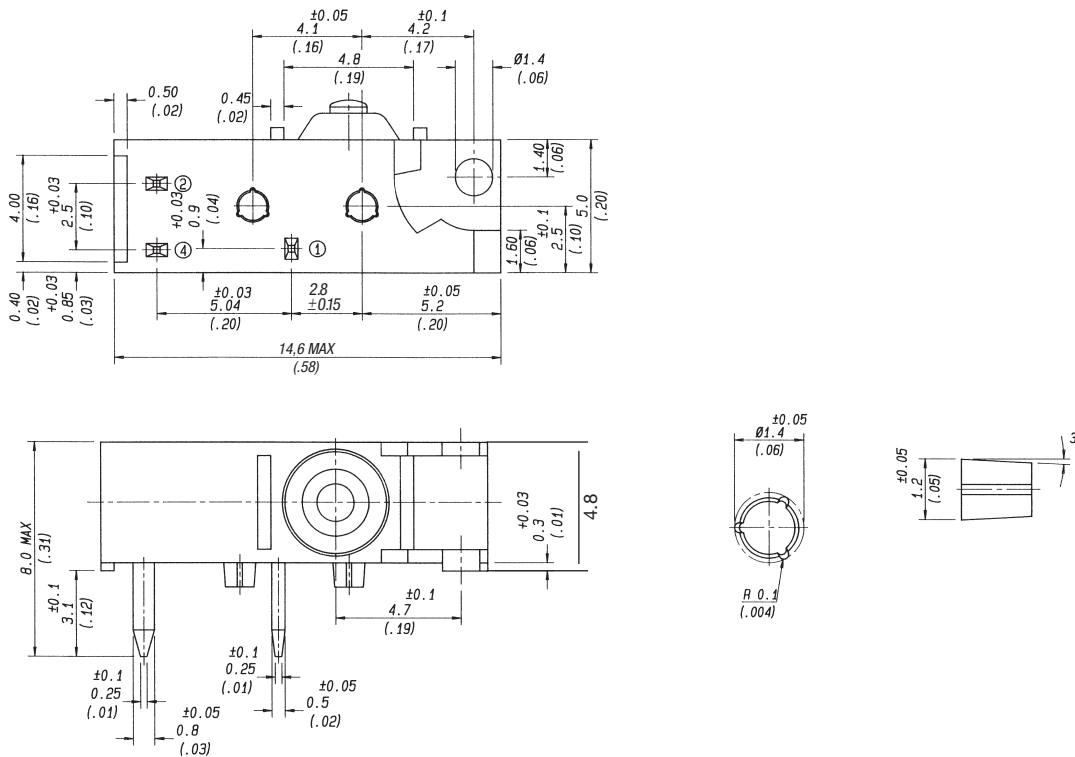

## Recommended maximum electrical ratings

Voltage (VAC)	Resistive load (A)	Inductive load (A)	Voltage (VDC)	Resistive load (A)	Inductive load (A)
125	1	1	up to		
250	1	1	30	2	2
			50	0,5	0,5
			75	0,25	0,25
			125	0,2	0,03

## Operating Characteristics

Actuator	Reference	Actuating Force Maximum		Release Force Minimum		Free Position		Operating Position Maximum		Movement Differential Maximum		Total travelled position Maximum	
		(N)	(ozf)	(N)	(ozf)	(mm)	(in)	(mm)	(in)	(mm)	(in)	(mm)	(in)
Plunger	F1NST8	2	7,20	0,2	0,72	6,5	0,26	5,9 ± 0,2	0,23 ± 0,008	0,2	0,008*		



A1-Lever	F1NST8A1	0,6	2,20	0,09	0,32	10,5	0,41	7,6 ± 1,2	0,3 ± 0,05	0,7	0,03 *		
----------	----------	-----	------	------	------	------	------	-----------	------------	-----	--------	--	--

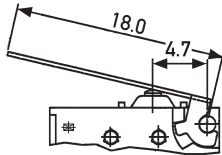

Width of lever 3 mm/0,12 in

AC-Lever	F1NST8AC	0,6	2,20	0,09	0,32	13,3	0,52	10,1 ± 1,2	0,4 ± 0,05	0,7	0,03 *		
----------	----------	-----	------	------	------	------	------	------------	------------	-----	--------	--	--

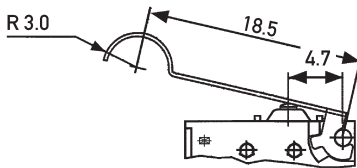

Width of lever 3 mm/0,12 in

Datum for Free Position and Operating Position: base of switch opposite plunger.

\* Flush with case. The case should not be used as an end stop.

## Ordering Reference

Basic type	F1N	Example: F1N	S	T8	A	AU
Type of sealing	S	No symbol, unsealed Sealed IP5K4				
Terminals	T8	PCB 0.8 × 0.5 × 3.45 long				
Circuit		No symbol, change-over				
Actuators	A A1 AC	No symbol, without lever Special lever A type (see specification) Plain lever 18.0 mm Cam follower lever 18.5 mm				
Contact Material	AU GP	No symbol, Ag Gold on nickel Gold plate on Ag (GP)				
Special Features	/□□□□	Burgess specialise in customer specific solutions. Additional product variants are available or can be provided. If your requirements cannot be satisfied from the options listed, please contact us.				

# L16

## L16

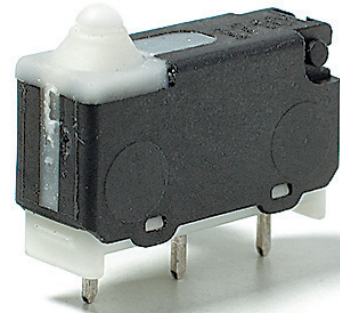

Characteristics	<ul style="list-style-type: none"><li>■ small size</li><li>■ sealed (IP6K7)</li><li>■ PCB mounting</li></ul>
Rating	12–30 VDC, 1–300 mA
Dimensions (mm)	14.7 × 9 × 5.4
Actuator	<ul style="list-style-type: none"><li>■ plunger</li><li>■ plain lever</li><li>■ cam follow lever</li></ul>
Approvals	Automotive standard

## Preferred Range

Ordering Reference	Actuating Force (N)	Sealing	Operating pos. (mm)	Terminal	Circuit	Actuator	Contacts	Electrical rating
L16T8	1,6	IP6K7	10,9	PCB	CO	Plunger	Gold plated	30 VDC, 300 mA

## Specifications

Base	PBT
Lid	PP6 with glass fibre
Plunger	POM
Mechanism	Snap-action, single pole
Contacts	Gold plated
Terminals	CuZn
Temperature range °C	-40°C up to +85°C
Mechanical life	1 × 10 <sup>6</sup>
Protection	IP67
Actuators	Plain plunger, lever, cam follower stainless steel
Cowl	Thermoplastic elastomer

Circuit diagram

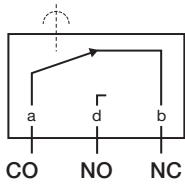

Dimensions L16T85

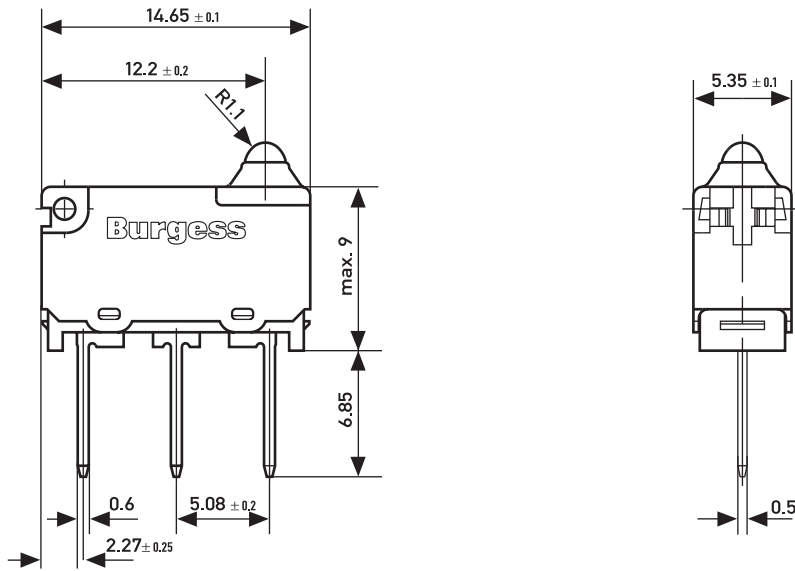

## Recommended maximum electrical ratings

Voltage (VDC)	Resistive load (A)	Cycles
L16 12 to 30	0,001 – 0,3	200.000

## Operating Characteristics

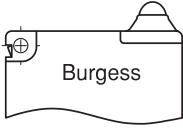
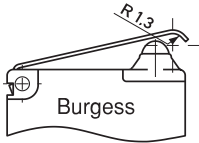
Actuator	Reference	Actuating Force Maximum (N)	Release Force Minimum (N)	Free Position Maximum (mm)	Operating Position (mm)	Movement Differential Maximum (mm)	Total travelled positions Minimum (mm)
Plunger	L16	1,6	0,3	11,35	10,8 ± 2	0,3	9,5
							
H-Lever	L16-H	2,5	0,5	12,9	11,3 ± 0,55	0,45	10
							

Width of lever 3.0 mm/0.12 in

Datum for free position and operating position is button edge of base (stand-off's).  
The case should not be used as an end stop.

## Ordering Reference

Basic type	L16	Example: F6 T8 H	
Terminals	T8 PCB	0.6 × 0.5 × 4.0 long	
	T81 Formed PCB	0.6 × 0.5 × 2.35 long (Side mount L.H. plunger end)	
	T82 Formed PCB	0.6 × 0.5 × 2.85 long (Side mount R.H. plunger end)	
	T84 Short PCB	0.6 × 0.5 × 2.0 long	
	T85 Long PCB	0.6 × 0.5 × 6.85 long	
Circuit	No symbol, change-over		
Actuators	No symbol, without lever		
	H	Formed. lever 0.3 mm thickness	
	Y1	Plain lever 21 mm	
	YC	Cam follower lever 16.9 mm	
	HC	Cam follower	
Contact Material	No symbol, gold plated		
Special Features	<input type="checkbox"/> <input type="checkbox"/> <input type="checkbox"/> <input type="checkbox"/> Burgess specialise in customer specific solutions. Additional product variants are available or can be provided. If your requirements cannot be satisfied from the options listed, please contact us.		

# FK4

## FK4

Characteristics	<ul style="list-style-type: none"> <li>■ double break switching</li> <li>■ long mechanical and electrical life</li> <li>■ solder</li> </ul>
Rating	250 VAC, 5 A
Dimensions (mm)	18 × 8 × 5
Actuator	<ul style="list-style-type: none"> <li>■ plunger</li> <li>■ plain lever</li> <li>■ simulated roller lever/cam follower</li> </ul>
Approvals	UL and CSA

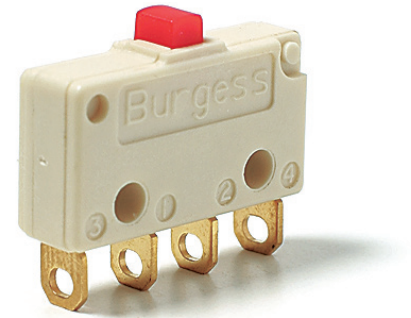

## Preferred Range

Ordering Reference	Actuating Force (N)      (ozf)		Sealing	Operating pos. (mm)      (in)		Terminal	Circuit	Actuator	Contacts	Electrical rating
FK4T7UL	1,8	6,5	IP40	8,25	0,32	Solder	SPDT	Plunger	Ag	Up to 250 VAC, 5 A
FK4T7Y1UL	0,8	2,9	IP40	8,25	0,32	Solder	SPDT	Plain lever	Ag	Up to 250 VAC, 5 A
FK4T7YCUL	1,0	3,6	IP40	10,40	0,41	Solder	SPDT	Simulated roller	Ag	Up to 250 VAC, 5 A

## Specifications

Housing	Glass fibre reinforced flame retardent nylon
Plunger	Nylon
Mechanism	Double pole, single throw snap-action coil spring mechanism with stainless steel springs
Functions	Change-over, NO, NC
Contacts	Silver
Terminals	Solder, PCB - brass, gold flashed
Temperature range °C	-40°C to +85°C
Mechanical life	10 <sup>7</sup> cycles minimum (impact free actuation)
Protection	IP40 (enclosure)
Mounting	Side mounting or PCB mounting (T8 only)
Actuators	Plain lever, simulated roller lever/cam follower, stainless steel

Circuit diagram

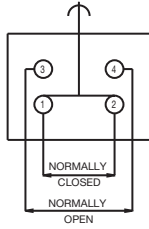

Dimensions

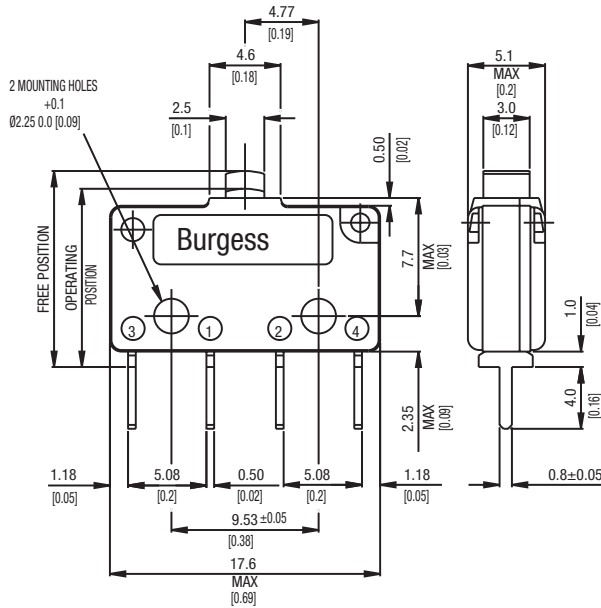

## Recommended maximum electrical ratings

Voltage (max)	Load (A)	Approval
250 VAC	5 (0.75 pf)	UL 1054/CSA 22.2 No. 55 - 6,000 operations
125 VAC	5 (0.75 pf)	UL 1054/CSA 22.2 No. 55 - 6,000 operations
0 - 15 VDC	5	General rating - 50,000 operations
15 - 30 VDC	3	General rating - 50,000 operations

Values shown are recommended maximum ratings for single circuit switching

## Operating Characteristics

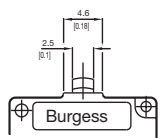
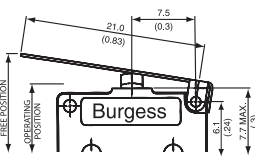
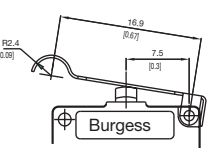
Actuator	Reference	Actuating Force		Release Position		Free Position Maximum (mm)	Operating Differential		Movement		
		Maximum (N)	Force (ozf)	Minimum (N)	(ozf)		(in)	Maximum (mm)	(in)	(mm)	(in)
Plunger 	FK4T7*	1,8	6,50	0,25	0,9	9,4	0,37	8,25 ± 0,25	0,32 ± 0,01	0,50	0,02
Y1 Lever 	FK4T7Y1	0,8	2,90	0,09	0,3	12,1	0,48	8,25 ± 0,9	0,32 ± 0,04	1,85	0,07
Width of lever 3.0 mm/0.12 in											
YC Lever 	FK4T7YC	1,0	3,60	0,1	0,4	13,5	0,53	10,40 ± 0,6	0,41 ± 0,02	1,30	0,05
Width of lever 3.0 mm/0.12 in											

Overtravel: Plunger can be depressed flush with housing. The housing should not be used as an end stop.

Datum for free position and operating position

\* FK4T7 – Center of fixing hole

## Ordering Reference

Basic type	FK4	Example: FK4			T7	Y1	UL
Terminals	T7	Solder	0,5 × 3,5 × 3,6 long				
Actuators	Y1	No symbol, plunger					
	YC	Plain lever					
		Simulated roller lever/cam follower					
Approvals	UL	UL and CSA					



# Long overtravel Microswitches

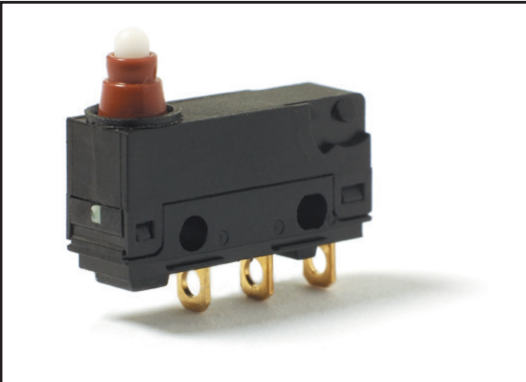

Circuit diagram

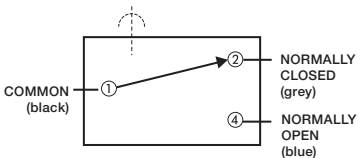

Dimensions

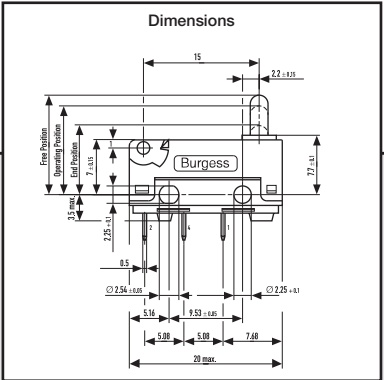

## V4L

Characteristics	<ul style="list-style-type: none"> <li>■ long overtravel of 2.2 mm minimum</li> <li>■ sealed to (IP6K7) option</li> <li>■ pre-wired option</li> <li>■ solder terminals</li> <li>■ compliant to glow wire test IEC 60335-1, 4. ed. as optional item</li> </ul>
Rating	250 VAC, 5 A
Dimensions (mm)	20 × 11 × 6.4
Actuator	<ul style="list-style-type: none"> <li>■ plunger</li> <li>■ plain lever</li> <li>■ ice break lever</li> </ul>
Approvals	ENEC, UL, CSA

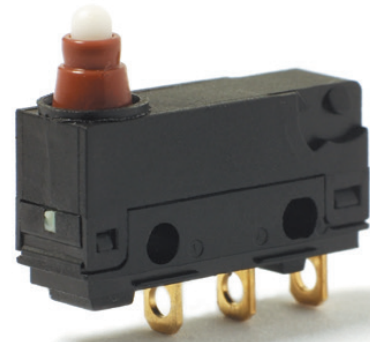

## Preferred Range

Ordering Reference	Actuating Force (N)	Actuating Force (ozf)	Sealing	Operating pos. (mm)	Terminal	Circuit	Actuator	Contacts	Electrical rating
V4LS	2,5	9,0	IP6K7	11,7 ± 0,4	Cable 500 mm	CO	Plunger	Ag	250 VAC, 5 A
V4LSA2	2,0		IP6K7	16,5 ± 1,0	Cable 500 mm	CO	Plain lever	Ag	250 VAC, 5 A
V4LST7	2,5	9,0	IP6K7	11,7 ± 0,4	Solder	CO	Plunger	Ag	250 VAC, 5 A
V4LST7A2	2,0		IP6K7	14,6 ± 1,0	Solder	CO	Plain lever	Ag	250 VAC, 5 A

## Specifications

Housing	Glass fibre reinforced polyamide (PA 6.6)
Plunger	Polyacetal (POM)
Mechanism	Snap-action coil spring mechanism with stainless steel spring. Change-over, normally closed or normally open
Contact carrier	Brass. Moving contact beryllium-copper
Contacts	Fine silver or gold crosspoint
Terminals	V4L – solder tags V4LS – PVC covered leads 0.5 m long
Temperature range °C	–40°C to +85°C
Mechanical life	V4L 2 T 10 <sup>6</sup> cycles/min., V4LS 2 T 10 <sup>5</sup> cycles/min. (impact free actuation)
Protection	V4L series IP40, V4LS series IP6K7, with encapsulated terminals
Mounting	Side mounting to a flat surface
Actuators	Plain lever, ice break lever, stainless steel
Cowl	Silicon elastomer

Circuit diagram

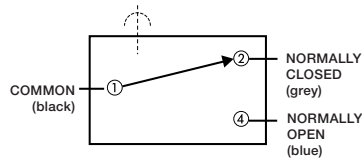

Dimensions

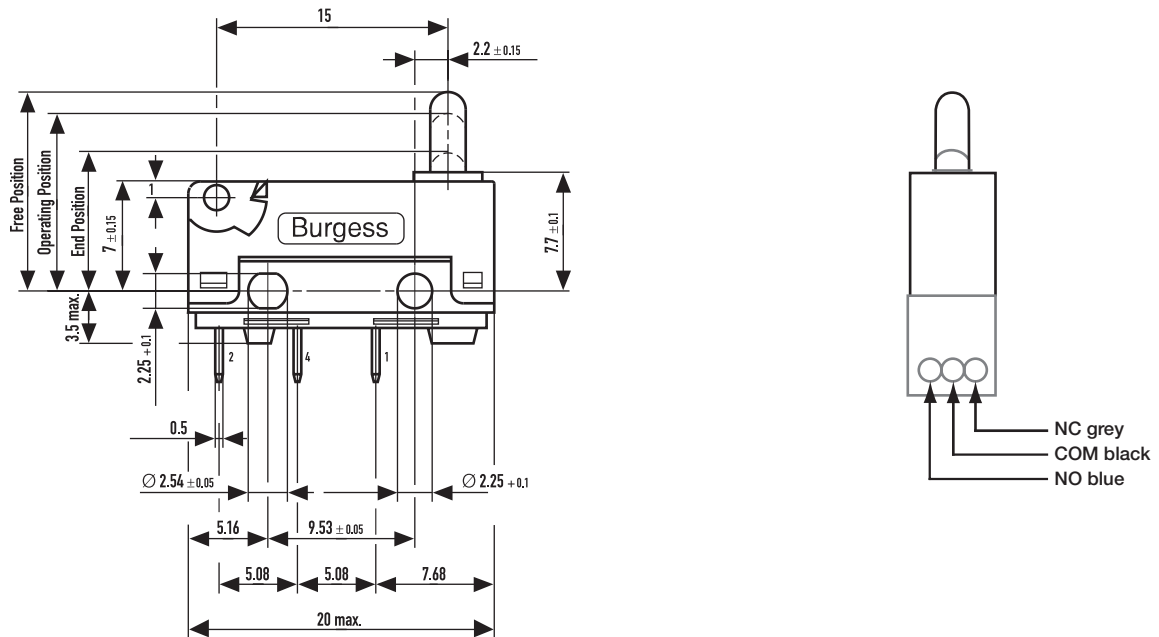

## Recommended maximum electrical ratings

	Voltage (max)	Resistive load (A)	Motor load (A)	Approval
V4LST7	250 VAC	5 (0,75 pf)		UL 1054/CSA 22,2 No. 55–6,000 operations – 65°C EN61058-1, T55, 50,000 operations
	250 VAC	5	2	
	0–15 VDC	5	3	General rating – 50,000 operations (85°C)
	15–30 VAC	5	3	General rating – 50,000 operations (85°C)
V4LS	250 VAC	5 (0,75 pf)		UL 1054/CSA 22,2 No. 55–6,000 operations – 65°C EN61058-1, T55, 50,000 operations
	250 VAC	5	2	
	0–15 VDC	3	3	General rating – 50,000 operations (85°C)
	15–30 VAC	3	3	General rating – 50,000 operations (85°C)

## Ordering Reference

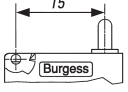
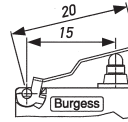
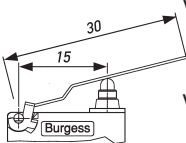
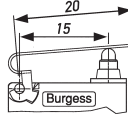
Actuator	Reference	Actuating Force		Release Position		Free Position		Operating		Movement Differential		Total overtravel		Overtravel	
		Maximum (N)	(ozf)	Minimum (N)	(ozf)	Maximum (mm)	(in)	(mm)	(in)	Maximum (mm)	(in)	Minimum (mm)	(in)	Minimum (mm)	(in)
Plunger 	V4LT7	2,4	8,60	0,4	1,44	12,9	0,507	11,7 ± 0,4	0,46 ± 0,012	0,9	0,023	9,2	0,36	2,2	0,09
	V4LST7	2,5	9,00	0,5	1,78	12,9	0,507	11,7 ± 0,4	0,46 ± 0,012	0,9	0,023	9,2	0,36	2,2	0,09
A1 Lever 	V4L...	2,4	8,60	0,4	1,44	14,5	0,57	12,6 ± 0,8	0,59 ± 0,03	1,0	0,04	9,6	0,38	2,2	0,09
	V4LS...	2,5	9,00	0,5	1,78	14,5	0,57	12,6 ± 0,8	0,59 ± 0,03	1,0	0,04	9,6	0,38	2,2	0,09
Width of lever 4.0 mm/0.16 in															
A2 Lever 	V4L...	1,5	5,70	0,3	1,08	16,5	0,65	13,5 ± 1,0	0,53 ± 0,04	1,3	0,05	9,6	0,38	2,9	1,1
	V4LS...	2	7,20	0,3	1,08	16,5	0,65	13,5 ± 1,0	0,53 ± 0,04	1,3	0,05	9,6	0,38	2,9	1,1
Width of lever 4.0 mm/0.16 in															
F Lever 	V4L...	For positions and forces of this actuator please contact Burgess													
	V4LS...														
Width of lever 4.0 mm/0.16 in															

## Ordering Reference

Basic type	V4L	Example: V4L   S   T7   A1   X   UL
Type of sealing	S	No symbol, unsealed Sealed IP6K7
Terminals	T7	No symbol, pre-wired 500 mm with cable FLRY 0.5 mm <sup>2</sup> and cable box (V4LS only) Solder 2.95 T 0.5 T 3.55 long
Circuit		No symbol, change over
Actuators	A1 A2 F	No symbol, without lever Plain lever 20.0 mm, fitted at the end opposite to plunger Plain lever 30.0 mm, fitted at the end opposite to plunger Special lever F type 20.0 mm, fitted at the end opposite to plunger
Contact Material	X	No symbol, Ag Gold alloy on silver palladium crosspoint (AUX)  Other contact materials on special request
Approvals	UL EN UN	No symbol, without approval UL and CSA approval ENEC approval only UL, CSA and ENEC approval
Special Features	/□□□□	Burgess specialise in customer specific solutions. Additional product variants are available or can be provided. If your requirements cannot be satisfied from the options listed, please contact us.

# Sealed Microswitch

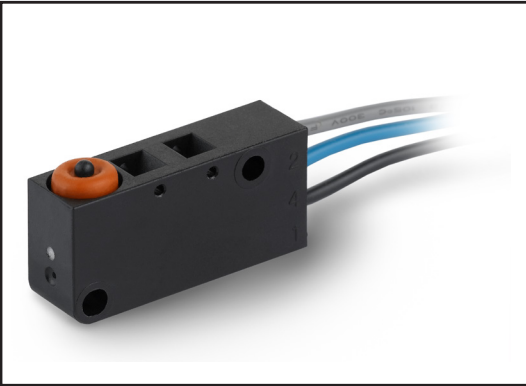

Circuit diagram

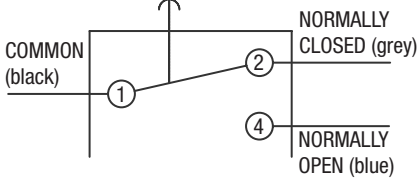

Dimensions

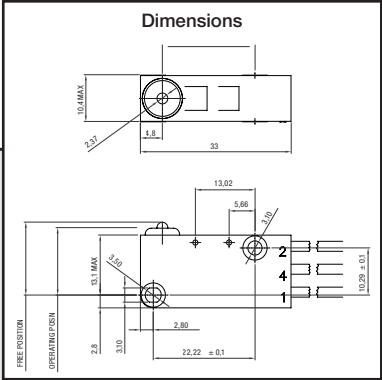

## V3NS

Characteristics	<ul style="list-style-type: none"> <li>■ sealed (IP67)</li> <li>■ pre-wired option</li> <li>■ faston terminals</li> <li>■ robust construction</li> <li>■ compliant to glow wire requirements IEC 60335</li> </ul>
Rating	250 VAC, 6 A
Dimensions (mm)	33 x 15.9 x 10.4
Actuator	<ul style="list-style-type: none"> <li>■ plunger</li> <li>■ plain levers</li> <li>■ roller levers</li> <li>■ cam follower lever</li> </ul>
Approvals	UL, CSA, ENEC



Miniature sealed

## Preferred Range

Ordering Reference	Actuating Force max. (N)	Actuating Force max. (ozf)	Sealing	Operating position (mm)	Operating position (in)	Terminal	Circuit	Actuator	Contacts	Electrical rating
V3NSUL	2.2	8.0	IP67	14.7 ± 0.4	0.58 ± 0.016	Pre-wired	CO	Plunger	Ag	Up to 250VAC, 6A
V3NSY1UL	1.3	4.7	IP67	16.3 ± 0.85	0.64 ± 0.034	Pre-wired	CO	Plain lever	Ag	Up to 250VAC, 6A
V3NSYRUL	2.6	8.0	IP67	21.0 ± 0.45	0.83 ± 0.018	Pre-wired	CO	Roller lever - short	Ag	Up to 250VAC, 6A
V3NSYR1UL	1.6	4.7	IP67	21.7 ± 0.8	0.85 ± 0.032	Pre-wired	CO	Roller lever - long	Ag	Up to 250VAC, 6A
V3NSYCUL	1.6	4.7	IP67	19.45 ± 0.8	0.77 ± 0.032	Pre-wired	CO	Cam follower lever	Ag	Up to 250VAC, 6A
V3NST1UL	2.2	8.0	IP67	14.7 ± 0.4	0.58 ± 0.016	Faston	CO	Plunger	Ag	Up to 250VAC, 6A
V3NST1Y1UL	1.3	4.7	IP67	16.3 ± 0.85	0.64 ± 0.034	Faston	CO	Plain lever	Ag	Up to 250VAC, 6A
V3NST1YRUL	2.6	8.0	IP67	21.0 ± 0.45	0.83 ± 0.018	Faston	CO	Roller lever - short	Ag	Up to 250VAC, 6A
V3NST1YR1UL	1.6	4.7	IP67	21.7 ± 0.8	0.85 ± 0.032	Faston	CO	Roller lever - long	Ag	Up to 250VAC, 6A
V3NST1YCUL	1.6	4.7	IP67	19.45 ± 0.8	0.77 ± 0.032	Faston	CO	Cam follower lever	Ag	Up to 250VAC, 6A

## Specifications

Housing	Glass fibre reinforced flame retardant nylon
Plunger	Polyphenylene Sulphide
Mechanism	Snap-action, single pole
Functions	Change-over
Cowl	Silicone Rubber
Contacts	Silver
Terminals	Pre-wired, Faston
Temperature Range	-40°C to +85°C
Mechanical Life	1 million cycles minimum (impact free operation)
Protection	IP67 (enclosure)
Mounting	Side mounting
Actuators	Plain lever, cam follower lever - stainless steel, roller levers - stainless steel, acetal roller

Circuit diagram

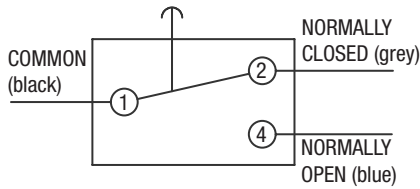

Dimensions

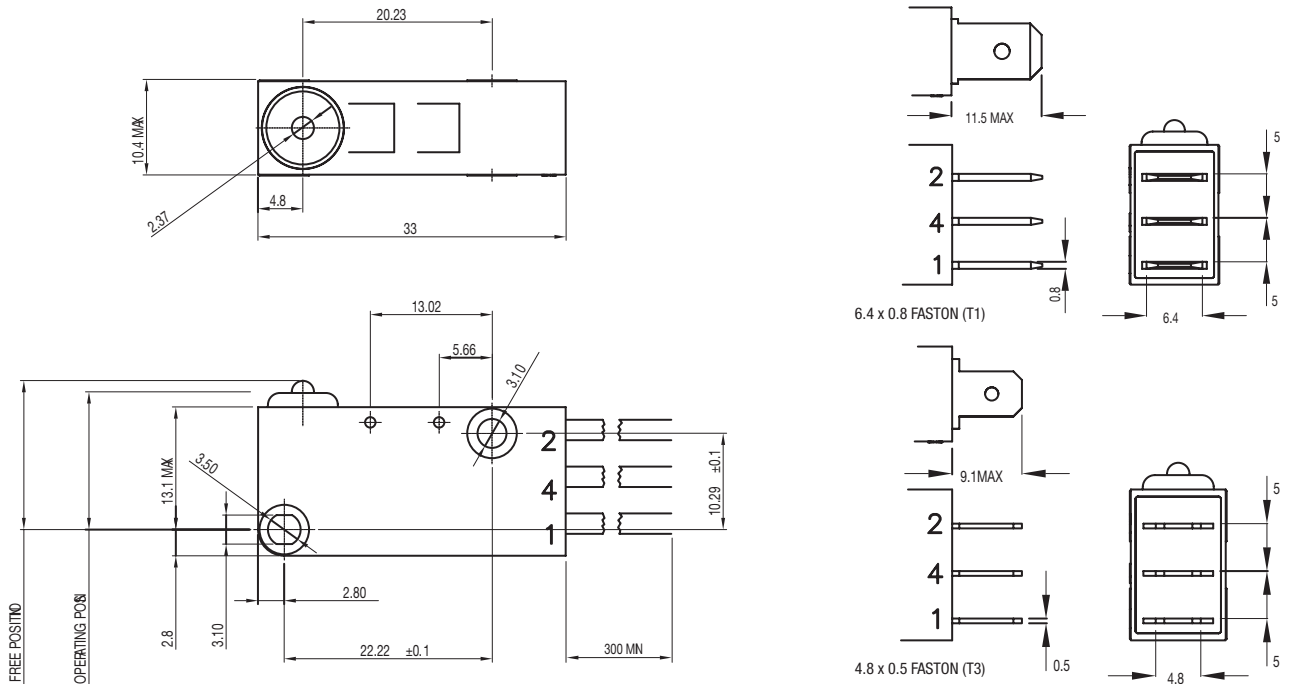

## Recommended maximum electrical ratings

Voltage (max)	Load (A)	Approval
125 VAC	6 (0.75pf)	UL 1054/CSA 22.2 No.55 - 6000 operations (85°C)
250 VAC	6 (0.75pf)	UL 1054/CSA 22.2 No.55 - 6000 operations (85°C)
250 VAC	6 (2)	EN61058-1, T85 50,000 operations
250 VAC	4	General inductive rating - 200,000 operations minimum
250 VAC	5	General resistive rating - 200,000 operations minimum
30 vdc	5	General resistive rating - 200,000 operations minimum
5 vdc	0.001	General resistive rating - 1 million operations minimum

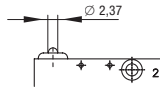
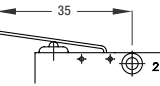
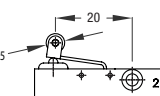
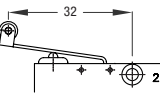
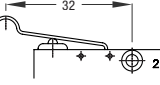

## Operating Characteristics

Actuator	Reference	Actuating Force		Release Force		Free Position		Operating Position		Movement Differential	
		Maximum (N)	(ozf)	Minimum (N)	(ozf)	Maximum (mm)	(in)	(mm)	(in)	Maximum (mm)	(in)
Plunger 	V3NSUL V3NST1UL V3NST3UL	2.2	8.0	0.4	1.4	16	0.63	14.7 ± 0.4	0.58 ± 0.016	0.25	0.01
Y1 lever  Widt of lever 4.74	V3NSY1UL V3NST1Y1UL V3NST3Y1UL	1.3	4.7	0.2	0.7	19	0.75	16.3 ± 0.85	0.64 ± 0.034	1.1	0.05
YR lever  Widt of roller 6.1	V3NSYRUL V3NST1YRUL V3NST3YRUL	2.6	8.0	0.4	1.4	22.5	0.89	21.0 ± 0.45	0.83 ± 0.018	0.28	0.013
YR1 lever  Widt of roller 6.1	V3NSYR1UL V3NST1YR1UL V3NST3YR1UL	1.6	4.7	0.2	0.7	24.1	0.95	21.7 ± 0.8	0.85 ± 0.032	0.5	0.02
YC lever  Widt of lever 4.74	V3NSYCUL V3NST1YCUL V3NST3YCUL	1.6	4.7	0.2	0.7	23	0.91	19.45 ± 0.8	0.77 ± 0.032	0.5	0.02

Operating characteristics are specified from the lower mounting hole  
Overtravel: Plunger can be depressed flush with housing. The housing should not be used as an end stop

## Ordering Reference

Basic type	V3NS	Example: V3NS	T3	C2	Y1	UL
Terminals	No symbol, pre-wired with standard 300mm cables					
T1	6.4 x 0.8 Faston					
T3	4.8 x 0.5 Faston					
Circuit	No symbol, change-over					
C2	Normally closed					
C4	Normally open					
Actuators	No symbol, without lever or actuator					
Y1	Plain lever 35mm					
YR	Roller lever 20mm					
YR1	Roller lever 32mm					
YC	Cam follower lever 32mm					
Contact Material	No symbol. Ag					
Approvals	No symbol, without approval					
UL	UL, CSA, ENEC Approval					
Special Features	/□□□□	Burgess specialise in customer specific solutions Additional product variants are available or can be provided If your requirements cannot be satisfied from the options listed, please contact us.				

Miniature sealed

## V3S

Characteristics ■ sealed (IP67)  
 ■ pre-wired  
 ■ robust construction

Rating 250 VAC, 5 A

Dimensions (mm) 32 × 24 × 10

Actuator ■ plunger  
 ■ plain levers  
 ■ roller levers

Approvals UL, CSA, ENEC

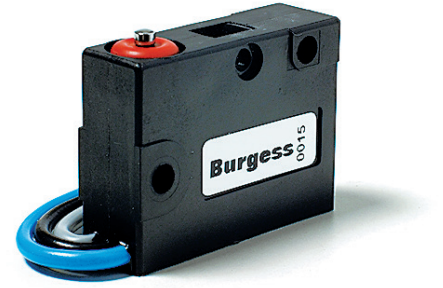

## Preferred Range

Ordering Reference	Actuating Force (N) (ozf)		Sealing	Operating pos. (mm) (in)		Terminal	Circuit	Actuator	Contacts	Electrical rating
V3SUL	3,9	14,00	IP67	14,5	0,57	Pre-wired	CO	Plunger	Ag	Up to 250 VAC, 5 A
V3SYRUL	3,9	14,00	IP67	20,4	0,80	Pre-wired	CO	Roller lever - short	Ag	Up to 250 VAC, 5 A
V3SYR1UL	2,3	8,26	IP67	22,0	0,86	Pre-wired	CO	Roller lever - long	Ag	Up to 250 VAC, 5 A
V3SY1UL	1,7	7,50	IP67	14,9	0,55	Pre-wired	CO	Plain lever	Ag	Up to 250 VAC, 5 A

## Specifications

Housing	Glass fibre reinforced flame retardent nylon
Plunger	Acetal (lever types), stainless steel (plunger types)
Mechanism	Snap-action, single pole
Functions	Change-over
Cowl	Silicone rubber
Contacts	Silver
Terminals °C	Pre-wired
Temperature range	-40°C to +85°C
Mechanical life	10 <sup>6</sup> cycles minimum, impact-free actuation
Protection	IP67 (enclosure)
Mounting	Side mounting
Actuators	Plain lever - stainless steel, Roller levers - stainless steel, nylon roller

Circuit diagram

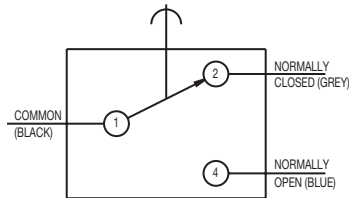

Dimensions

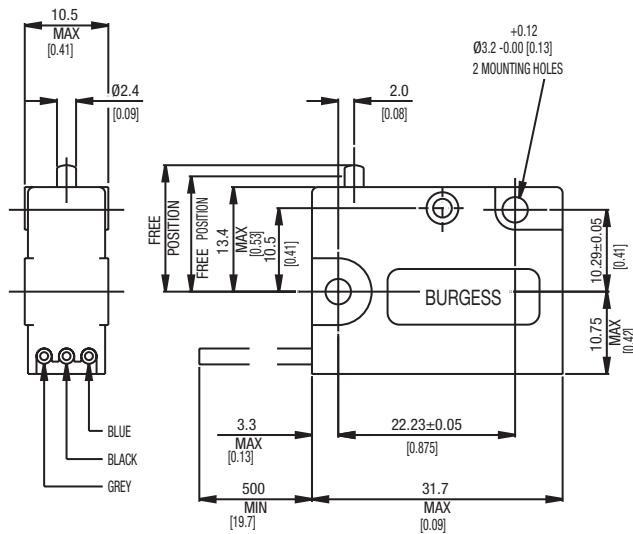

## Recommended maximum electrical ratings

Voltage (max)	Load (A)	Approval
125 VAC	5 (0.75 pf)	UL 1054/CSA 22.2 No. 55 - 6,000 operations (85°C)
250 VAC	5 (0.75 pf)	UL 1054/CSA 22.2 No. 55 - 6,000 operations (85°C)
250 VAC	5	EN61058-1, T85, 10,000 operations
0 - 15 VDC	6	General rating - 50,000 operations (85°C)
15 - 30 VDC	3	General rating - 50,000 operations (85°C)

## Operating Characteristics

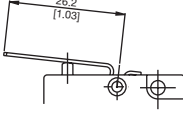
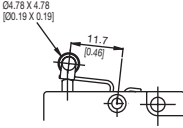
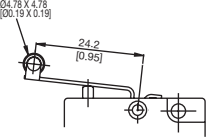
Actuator	Reference	Actuating Force		Release Force		Free Position		Operating Position		Movement Differential	
		Maximum (N)	(ozf)	Minimum (N)	(ozf)	Maximum (mm)	(in)	(mm)	(in)	Maximum (mm)	(in)
Plunger 	V3SUL	3,90	14,0	1,10	4,00	15,9	0,63	14,5 ± 0,5	0,57 ± 0,02	0,4	0,016
Plain lever 	V3SY1UL	1,65	6,0	0,42	1,50	13,4	0,71	14,9 ± 1,0	0,59 ± 0,4	1,0	0,040
Roller lever - short 	V3SYRUL	3,90	14,0	1,10	4,00	22,1	0,87	20,45 ± 0,64	0,8 ± 0,025	0,40	0,016
Roller lever - long 	V3SYR1UL	1,65	7,5	0,42	1,50	18,1	0,71	14,9 ± 01.0	0,55 ± 0,039	1,00	0,040

Over travel: Plunger can be depressed flush with housing. The housing should not be used as an end stop.

## Ordering Reference

Basic type	V3S	Example: V3S	Y1	UL
Circuit	No symbol, change-over			
Actuators	No symbol, without lever or actuator			
Y1	Plain lever 26.2 mm			
YR	Roller lever 11.7 mm			
YR1	Roller lever 24.2 mm			
Contact Material	No symbol, Ag			
Terminals	No symbol, fitted with standard 500 mm cables			
Approvals	No symbol, without approval			
UL	UL and CSA approval, ENEC			
Special Features	/□□□□	Burgess specialise in customer specific solutions. Additional product variants are available or can be provided. If your requirements cannot be satisfied from the options listed, please contact us.		

# Precision Switches



Circuit diagram

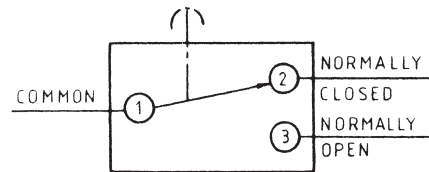

Dimensions

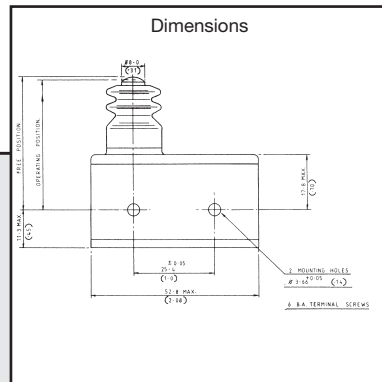

# 3BR

## 3BR

- Characteristics
- choice of IP54 or IP67 sealed versions
  - precise movements
  - screw terminals
  - pre-wired option
  - long overtravel

Rating 250 VAC, 10 A max.

Dimensions (mm) 53.1 × 20.6 × 30.8

Actuator ■ plunger

Approvals UL, CSA



## Preferred Range

Ordering Reference	Actuating Force (N) (ozf)	Sealing	Operating pos. (mm) (in)	Terminal	Circuit	Actuator	Contacts	Electrical rating
3BR103	7,2 26,00	IP54	39,3 1,55	Screw	CO	Plunger	Ag	Up to 125 VAC, 10 A
3BR510	7,2 26,00	IP67	39,3 1,55	Screw	CO	Plunger	Ag	Up to 125 VAC, 10 A

## Specifications

Housing	Phenolic
Plunger	Stainless steel
Cowl	Silicone rubber
Mechanism	Single pole change-over
Contacts	Silver
Terminals	Screw terminals with captive washers
Temperature	-10°C to +85°C
Mechanical life	10 <sup>8</sup> cycles minimum (impact free actuation)
Protection	3BR / 510 IP67 / 3BR103 IP54 (enclosure)
Mounting	Side mounting

Circuit diagram

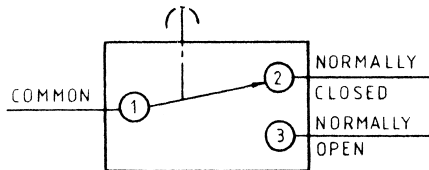

## Dimensions

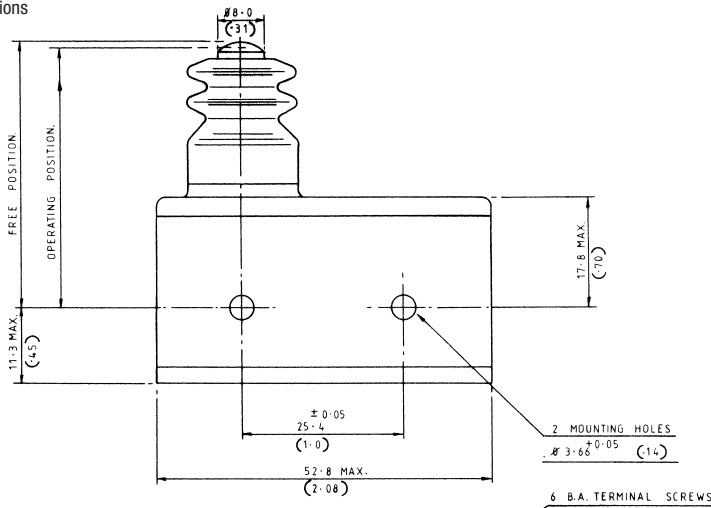

## Recommended maximum electrical ratings

Voltage (max)	Load (A)	Horsepower	Approval
250 VAC	5 (0.75 pf)	-	CSA 22.2 No. 55 - 6,000 operations
125 VAC	10 (0.75 pf)	-	CSA 22.2 No. 55 - 6,000 operations
250 VAC	-	¼ HP (0.45 pf)	CSA 22.2 No. 55 - 6,000 operations
125 VAC	-	¼ HP (0.45 pf)	CSA 22.2 No. 55 - 6,000 operations
0 - 15 VDC	10	-	General rating - 50,000 operations
15 - 30 VDC	5	-	General rating - 50,000 operations

## Operating Characteristics

Actuator	Reference	Actuating Force		Release Force		Free Position		Operating Position		Movement Differential Maximum		Overtravel	
		Maximum (N)	Maximum (ozf)	Minimum (N)	Minimum (ozf)	Maximum (mm)	Maximum (in)	(mm)	(in)	(mm)	(in)		
Plunger	3BR103	7,2	26,00	1,7	6	40,8	1,6	39,3 ± 0.4	1,55 ± 0.016	0,08	0,003	4,6	0,18

## Ordering Reference

Basic type	3BR	Example: 3BR   SH
Environmental sealing	SH 103 510	Sealed terminals with horizontal exiting 500 mm cables IP67 Sealed to IP54 Sealed to IP67
Special Features	/□□□□	Burgess specialise in customer specific solutions. Additional product variants are available or can be provided. If your requirements cannot be satisfied from the options listed, please contact <a href="http://www.saia-burgess.com">www.saia-burgess.com</a> or your local SB outlet.

# Metal housed Switches

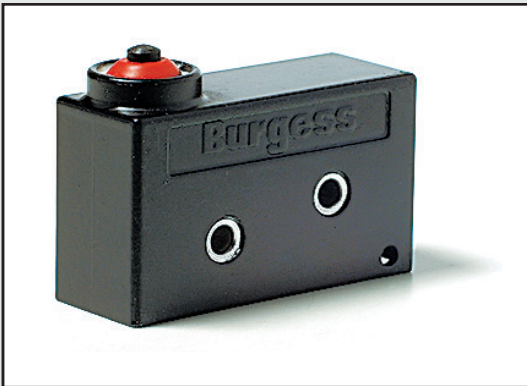

Circuit diagram

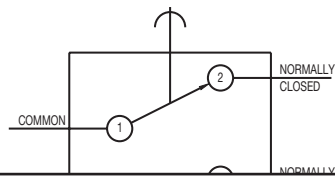

Dimensions

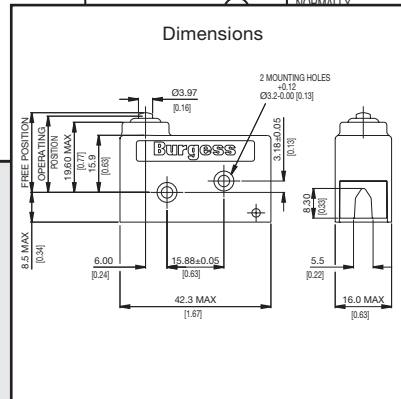



## V9N

- Characteristics
- sealed (IP67)
  - metal housed
  - screw terminals or flying leads
  - pre-wired option

Rating 250 VAC, 10 A max.

Dimensions (mm) 42 × 24.5 × 16

- Actuator
- plunger
  - plain levers
  - reverse action lever
  - roller lever

Approvals UL and CSA



## Preferred Range

Ordering Reference	Actuating Force (N)	Actuating Force (ozf)	Sealing	Operating pos. (mm)	Operating pos. (in)	Terminal	Circuit	Actuator	Contacts	Electrical rating
V9N	5,5	19,80	IP67	21,3	0,840	M3 screw	CO	Plunger	Ag	Up to 250 VAC, 10 A
V9NLR	6,0	21,60	IP67	27,5	1,080	M3 screw	CO	Roller lever - short	Ag	Up to 250 VAC, 10 A
V9NLR1	4,5	16,20	IP67	34,5	1,360	M3 screw	CO	Roller lever - long	Ag	Up to 250 VAC, 10 A
V9NLR	3,0	10,80	IP67	24,7	0,970	M3 screw	CO	Plain lever	Ag	Up to 250 VAC, 10 A

## Specifications

Housing	Zinc diecasting
Plunger	Acetal
Mechanism	Snap-action, single pole
Functions	Change-over
Cowl	Silicon rubber
Contacts	Silver
Terminals	M3 screws with captive washers or pre-wired
Temperature range	-40°C to +125°C, switch only -10°C to +85°C pre-wired and roller levers
Mechanical life	10 <sup>6</sup> cycles minimum, impact-free actuation
Protection	IP67 (enclosure)
Mounting	Side mounting
Actuators	Plain levers - stainless steel, roller levers - stainless steel, nylon roller

Circuit diagram

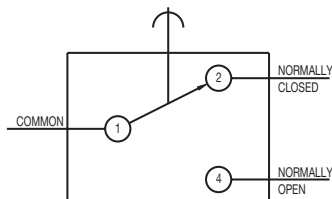

Dimensions

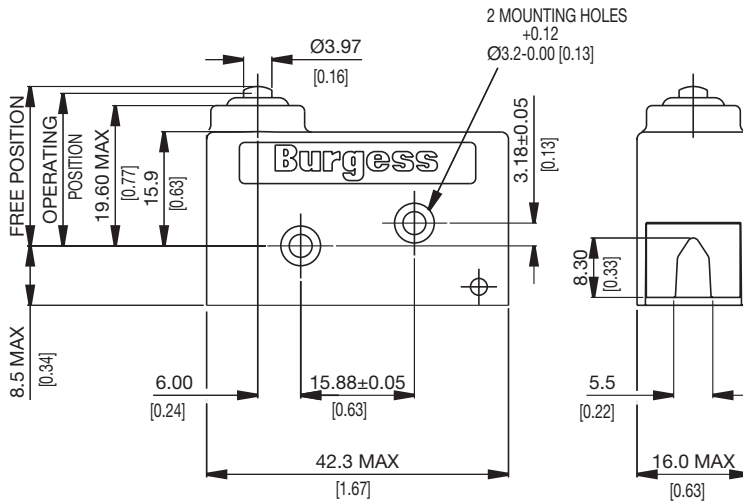

## Recommended maximum electrical ratings

Voltage (max)	Load (A)	Approval
250 VAC	10 (0.75 pf)	UL 1054/CSA 22.2 No. 55 - 6,000 operations (85°C)
0 - 15 VDC	10	General rating - 50,000 operations (85°C)
15 - 30 VDC	10	General rating - 50,000 operations (85°C)

## Operating Characteristics

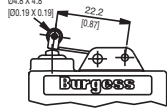
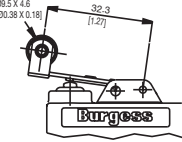
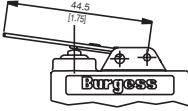
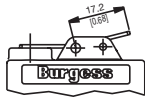
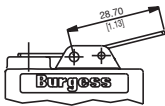
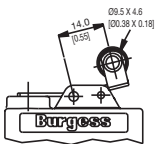
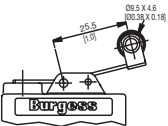
Actuator	Reference	Actuating Force		Release Force		Free Position		Operating Position		Movement Differential		Over travel Maximum	
		Maximum (N)	(ozf)	Minimum (N)	(ozf)	Maximum (mm)	(in)	(mm)	(in)	(mm)	(in)	(mm)	(in)
Plunger 	V9N	5,5	19,8	1,0	3,6	22,6	0,89	21,3 ± 0.3	0,84 ± 0.012	0,35	0,014	*	
Roller lever - short 	V9NLR	6,0	21,6	1,3	4,7	31,0	1,22	27,5 ± 0.5	1,08 ± 0.02	0,35	0,014	*	
Roller lever - long 	V9NLR1	4,5	16,2	0,8	2,9	39,0	1,54	34,5 ± 0.7	1,36 ± 0.028	0,60	0,024	*	
Plain lever 	V9NLR	3,0	10,8	0,6	2,1	31,0	1,22	24,7 ± 0.10	0,97 ± 0.039	0,70	0,028	*	
Reverse action lever - short 	V9NLM	7,5	27,0	1,5	5,4	26,0	1,02	22,4 ± 0.5	0,88 ± 0.02	0,50	0,020	3,50	0,137
Reverse action lever - long 	V9NLM1	4,5	16,2	1,0	3,6	29,0	1,14	23,6 ± 0.10	0,93 ± 0.039	1,20	0,047	6,00	0,236
Reverse action roller lever - short 	V9NLMR	9,5	34,2	1,5	5,4	36,0	1,42	32,9 ± 0.5	1,295 ± 0.02	0,45	0,018	2,00	0,079
Reverse action roller lever - long 	V9NLMR1	5,0	18,0	1,0	3,6	39,5	1,56	34,0 ± 0.10	1,34 ± 0.039	1,00	0,039	5,50	0,216

Operating characteristics are specified from lower mounting hole

\* Plunger can be depressed flush with housing. The housing should not be used as an end stop.

## Ordering Reference

Basic typ	V9N	Example: V9N	L	H
Actuators	No symbol, without lever			
L	Plain lever 44.5 mm			
LR	Roller lever 22.2 mm			
LR1	Roller lever 32.3 mm			
M	Reverse action lever 187.2 mm			
ML	Reverse action lever 28.7 mm			
MR	Reverse action roller lever 14.0 mm			
MLR	Reverse action roller lever 25.5 mm			
Terminals	No symbol, unwired			
H	Horizontal pre-wired cable			
V	Vertical pre-wired cable			
Pre-wired with Terminals H + V	No symbol, 1 m cable			
Special Features	/□□□□	Burgess specialise in customer specific solutions. Additional product variants are available or can be provided. If your requirements cannot be satisfied from the options listed, please contact us.		

# 4BR

## 4BR

Characteristics	<ul style="list-style-type: none"> <li>■ choice of IP54 or IP67 sealed versions</li> <li>■ precise movements and exceptional repeat accuracy</li> <li>■ robust metal housing</li> <li>■ flying lead version available</li> <li>■ long overtravel</li> </ul>
Rating	125 VAC, 10 A max.
Dimensions (mm)	53,1 × 20,6 × 29,2
Actuator	■ <b>plunger</b>
Approvals	UL, CSA



## Preferred Range

Ordering Reference	Actuating Force (N)	Actuating Force (ozf)	Sealing	Operating pos. (mm)	Operating pos. (in)	Terminal	Circuit	Actuator	Contacts	Electrical rating
4BR	7,2	26,00	IP54	39,3	1,550	Screw	CO	Plunger	Ag	Up to 125 VAC, 10 A
4BR510	7,2	26,00	IP67	39,3	1,550	Screw	CO	Plunger	Ag	Up to 125 VAC, 10 A
4BRSH	7.2	26,00	IP67	39,3	1,550	Pre-wired	CO	Plunger	Ag	Up to 125 VAC, 10 A

Metal housed

## Specifications

Housing	Zinc based alloy
Base Plate	Phenolic
Plunger	Stainless steel
Cowl	Silicon rubber
Mechanism	Single pole change-over
Contacts	Silver
Terminals	Removable screw terminals, insulated cover plate
Temperature	-10°C to +85°C
Mechanical life	10 <sup>6</sup> cycles minimum (impact free actuation)
Protection	4BR/510 IP67 / 4BR IP54 (enclosure)
Mounting	Side mounting

Circuit diagram

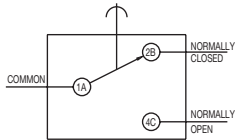

Dimensions

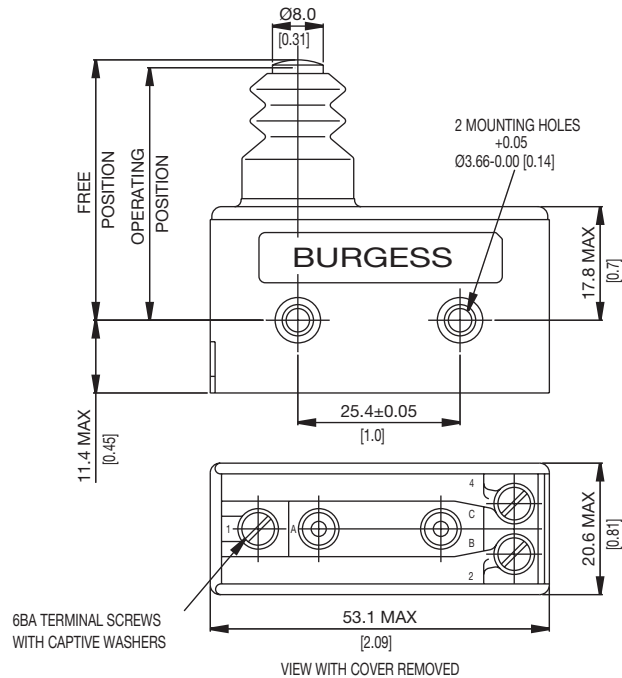

## Recommended maximum electrical ratings

Voltage (max)	Resistive load (A)	Inductive load	Horsepower	Approval
250 VAC	5 (0.75 pf)	5	-	CSA 22.2 No. 55 - 6,000 operations
125 VAC	10 (0.75 pf)	-	-	CSA 22.2 No. 55 - 6,000 operations
250 VAC	-	-	1/4 HP (0.45 pf)	CSA 22.2 No. 55 - 6,000 operations
125 VAC	-	-	1/8 HP (0.45 pf)	CSA 22.2 No. 55 - 6,000 operations
0 - 15 VDC	10	-	-	General rating - 50,000 operations
15 - 30 VDC	5	-	-	General rating - 50,000 operations

## Operating Characteristics

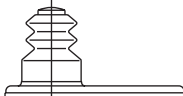
Actuator	Reference	Actuating Force		Release Force		Free Position		Operating Position		Movement Differential		Over travel	
		Maximum (N)	(ozf)	Minimum (N)	(ozf)	Maximum (mm)	(in)	(mm)	(in)	Maximum (mm)	(in)	(mm)	(in)
Plunger 	4BR	7,2	26,00	1,7	6	40,8	1,6	39,3 ± 0,4	1,55 ± 0,016	0,08	0,003	4,6	0,18
	4BR510	7,2	26,00	1,7	6	40,8	1,6	39,3 ± 0,4	1,55 ± 0,016	0,08	0,003	4,6	0,18
	4BRSH	7,2	26,00	1,7	6	40,8	1,6	39,3 ± 0,4	1,55 ± 0,016	0,08	0,003	4,6	0,18

## Ordering Reference

Basic type	4BR	Example: 4BR   SH
Environmental sealing	SH 103 510	Sealed terminals with horizontal exiting 500 mm cables IP67 Sealed to IP54 Sealed to IP67
Special Features	/□□□□	Burgess specialise in customer specific solutions. Additional product variants are available or can be provided. If your requirements cannot be satisfied from the options listed, please contact us.





# BVM3

## BVM3F

- Characteristics
- positive-action forced break switching
  - > 3 mm contact gap at full travel
  - internationally recognized V3 housing
  - faston terminals

Rating **250 VAC, 10 A**

Dimensions (mm) **28 × 16 × 10.5**

- Actuator
- plunger
  - plain lever
  - roller lever

Approvals ULS, CSA, ENEC

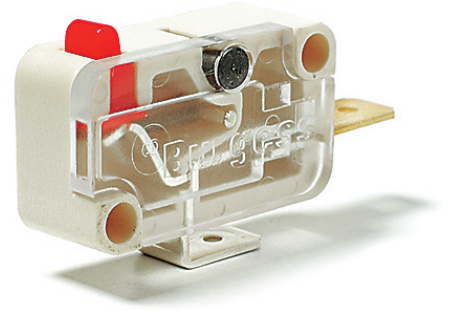

## Preferred Range

Ordering Reference	Actuating Force (N)	Actuating Force (ozf)	Sealing	Terminal	Circuit	Actuator	Contacts	Electrical rating
BVM3FULS	4.5	16.2	IP40	Faston	NC	Plunger	Ag/Ag nickel	Up to 250 VAC, 10 A
BVM3FYULS	4.5	16.2	IP40	Faston	NC	Plain lever	Ag/Ag nickel	Up to 250 VAC, 10 A
BVM3FYRULS	5.0	18.0	IP40	Faston	NC	Roller lever	Ag/Ag nickel	Up to 250 VAC, 10 A

## Specifications

Housing	Glass reinforced nylon
Plunger	Nylon
Mechanism	> 3 mm gap, positive-action, single pole
Functions	Normally closed
Contacts	Fixed silver nickel, Moving silver
Terminals	6.3 mm (0.25 in) faston NC (2) - brass, Common (1) - brass, Ag-plated
Temperature range °C	-40°C to +85°C
Mechanical life	10 <sup>6</sup> cycles minimum, impact-free actuation
Protection	IP40 (enclosure)
Mounting	Side mounting
Actuators	Plain lever - stainless steel, roller lever - stainless steel, nylon roller
Lid	Polycarbonate

Circuit diagram

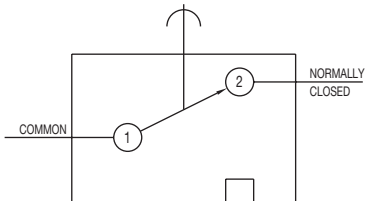

Dimensions

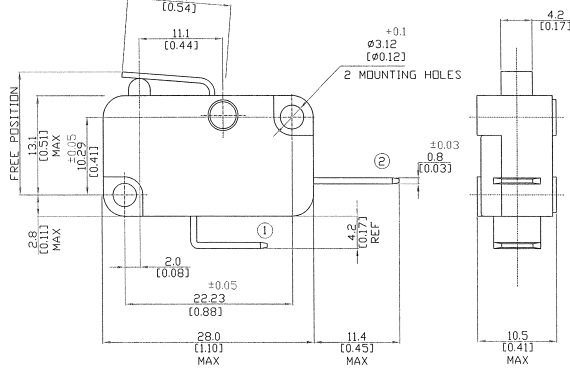

## Recommended maximum electrical ratings

Voltage (max)	Load (A)	Horsepower	Approval
250 VAC	10 (0.75 pf)	-	ULS 1054/CSA 22.2 No. 55 - 100,000 operations
250 VAC	-	½ HP	ULS 1054 - Horsepower - 6,000 operations
250 VAC	10 (3)	-	EN 61058-I T85 50,000 operations
125 VAC	-	1/2 HP	ULS 1054 - Horsepower - 6,000 operations

## Operating Characteristics

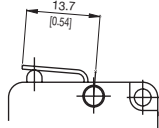
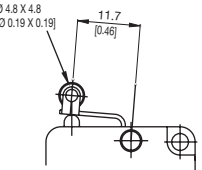
Actuator	Reference	Actuating Force at contact break		Actuating Force at total travel		Free Position		Contact gap at total travel	
		Maximum (N)	(ozf)	Minimum (N)	(ozf)	Maximum (mm)	(in)	Minimum (mm)	(in)
Plunger 	BVM3FULS	4,5	16,2	4,8	17,3	15,8	0,62	3,0	0,12
Y Lever 	BVM3FYULS	4,5	16,2	4,8	17,3	16,8	0,66	3,0	0,12
YR Lever 	BVM3FYRULS	5,0	18,0	5,5	19,8	22,35	0,88	3,0	0,12

Operating characteristics are specified from the mounting holes.

Total travel: Plunger can be depressed flush with housing. The housing should not be used as an end stop.

## Ordering Reference

Basic type	BVM3	Example: BVM3	F	Y	ULS
Terminals	F	Faston 6.3 × 0.8 mm			
Actuators	Y YR	No symbol, without lever Straight lever 13.7 mm Roller lever 11.7 mm			
Approvals	ULS	UL 100 k operations and CSA approval, ENEC			
Special Features	<input type="checkbox"/> <input type="checkbox"/> <input type="checkbox"/> <input type="checkbox"/>	Burgess specialise in customer specific solutions. Additional product variants are available or can be provided. If your requirements cannot be satisfied from the options listed, please contact us.			

# KB5

## KB5

- Characteristics
- positive-action forced double break switching
  - > 3 mm contact gap at full travel
  - high electrical rating
  - faston terminals

Rating Up to 250 VAC, 20 A

Dimensions (mm) 41 × 19,5 × 15.5

- Actuator
- plunger
  - plain lever
  - roller levers

Approvals ULS, CSA

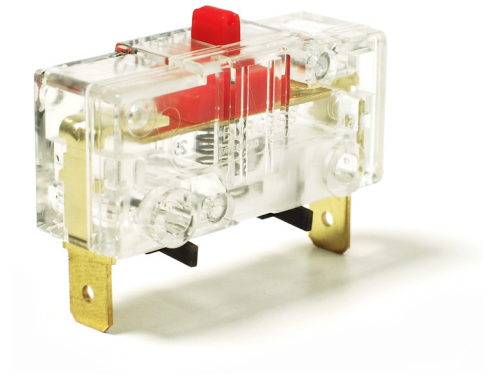

## Preferred Range

Ordering Reference	Actuating Force (N) (ozf)		Sealing	Operating pos (mm) (in)		Terminal	Circuit	Actuator	Contacts	Electrical rating
KB5FULS	3.00	10.0	IP40	16.8	0.66	Faston	NC	Plunger	Ag	Up to 250 VAC, 20 A
KB5FKULS	2.25	8.0	IP40	19.2	0.76	Faston	NC	Plain lever	Ag	Up to 250 VAC, 20 A
KB5FKRULS	2.25	8.0	IP40	31.0	1.22	Faston	NC	Roller lever	Ag	Up to 250 VAC, 20 A

## Specifications

Housing	Polycarbonate
Plunger	Nylon
Mechanism	Single pole, double break, positive action
Functions	Normally closed
Contacts	Fixed – silver, Moving – silver cadmium oxide
Terminals	6.3 mm (0.25 in) faston, brass
Temperature range	-40°C to +85°C
Mechanical life	10 <sup>7</sup> cycles minimum, impact-free actuation
Protection	IP40 (enclosure)
Mounting	Side mounting
Actuators	Plain lever - stainless steel, roller lever - stainless steel, nylon roller
Approvals	UL and CSA

Circuit diagram

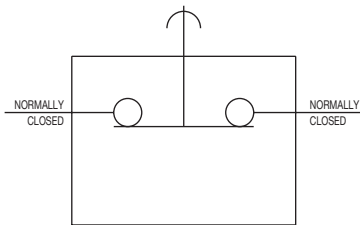

Dimensions

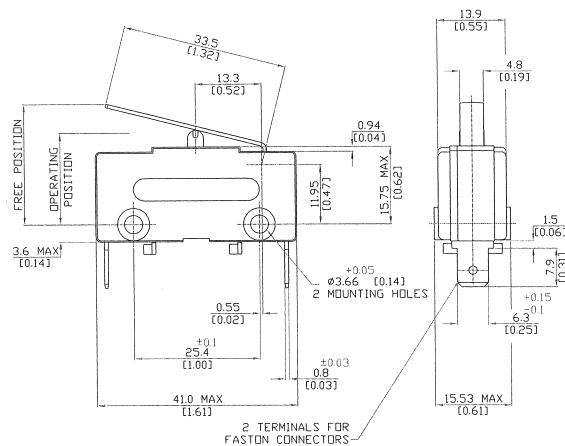

## Recommended maximum electrical ratings

Voltage (max)	Resistive load (A)	Inductive load	Horsepower	Approval
250 VAC	20 (0.75 pf)	-	-	ULS 1054/CSA 22.2 No. 55 - 100,000 operations
250 VAC	-	-	2 HP	ULS 1054 - Horsepower - 6,000 operations
125 VAC	-	-	1 HP	ULS 1054 - Horsepower - 6,000 operations

## Operating Characteristics

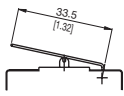
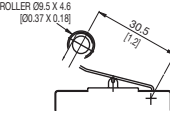
Actuator	Reference	Actuating Operation Position		Free Position		Contact gap at total travel			
		(N)	(ozf)	Maximum (mm)	Minimum (in)	(mm)	(in)	(mm)	(in)
Plunger 	KB5FULS	3,00	10,8	16,8	0,66	19,3	0,76	2 T 3.0	2 T 0.12
K Lever 	KB5FKULS	2,25	8,0	19,2	0,76	26,0	1,02	2 T 3.0	2 T 0.12
KR Lever 	KB5FKRULS	2,25	8,0	31,0	1,22	36,5	1,40	2 T 3.0	2 T 0.12

Recommended minimum contact separation 2 × 1,5 mm (2 × 0,6) indicated when groove in plunger lines up with case. Operating characteristics are specified from mounting holes.

Total travel: Plunger can be depressed flush with housing. The housing should not be used as an end stop.

## Ordering Reference

Basic type	KB5	Example: KB5   F   K   ULS
Terminals	F	Faston 6.3 × 0.8 mm
Actuators	No symbol, without lever K Plain lever 33.5 mm KR Roller lever 30.5 mm	
Approvals	ULS	UL 100 k operations and CSA approved
Special Features	/□□□□	Burgess specialise in customer specific solutions. Additional product variants are available or can be provided. If your requirements cannot be satisfied from the options listed, please contact us.

# Forced break Switches



Circuit diagram

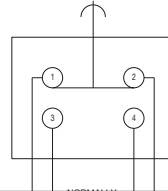

Dimensions

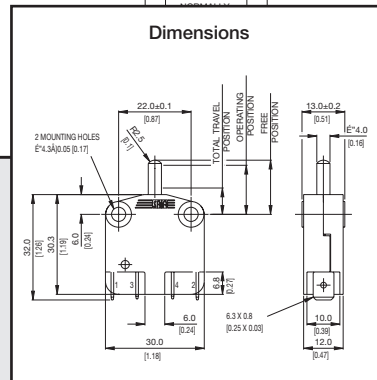

## XP

- Characteristics
- forced double break switching
  - positive-action force break option
  - > 3 mm contact gap at full travel option
  - faston terminals

Rating 400 VAC, 16 A

Dimensions (mm) 30 × 32 × 12

- Actuator
- plain plunger
  - mushroom plunger
  - plunger with external spring (for increased reset security)

Approvals ENEC, UL, CSA



## Preferred Range

Ordering Reference	Actuating Force (N)	Actuating Force (ozf)	Operating pos. (mm)	Operating pos. (in)	Terminal	Circuit	Actuator	Contacts	Electrical rating
XP2Z11	3,0	10,0	14,9	0,587	Faston	CO	Straight plunger	Ag nickel	Up to 400 VAC, 16 A
XP4Z11	1,8	6,2	14,9	0,587	Faston	NC	Straight plunger	Ag nickel	Up to 400 VAC, 16 A
XP5Z11	3,0	10,0	13,0	0,511	Faston	NO	Straight plunger	Ag nickel	Up to 400 VAC, 16 A
XP52E1Z11	6,5	23,3	13,0	0,511	Faston	NO	Mushroom plunger, reset	Ag nickel	Up to 400 VAC, 16 A
XP2E2Z11	3,0	10,0	14,9	0,587	Faston	CO	Mushroom plunger, reset	Ag nickel	Up to 400 VAC, 16 A



## Specifications

Housing	Glass fibre reinforced nylon
Plunger	Glass fibre reinforced nylon
Mechanism	Change-over, normally open, normally closed
Contacts	Silver
Terminals	6.3 mm (0.25 in) faston brass
Temperature range °C	-20°C to +140°C
Mechanical life	10 <sup>7</sup> cycles minimum (impact free actuation)
Protection	IP40 (enclosure)
Mounting	Screw mounting
Actuators	Straight or mushroom plunger
Special features	Optional reset spring for increased reset security

Circuit diagram

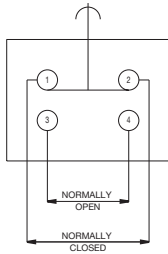

Dimensions

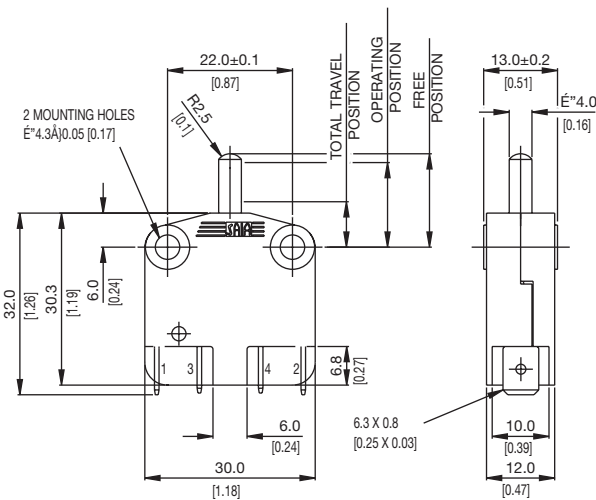

## Recommended maximum electrical ratings

Voltage (max)	Resistive load (A)	Inductive load	Horsepower	Approval
250 VAC	16 (0.75 pf)	-	-	UL 1054/CSA 22.2 No. 55 - 6,000 operations
125 VAC	-	-	¼ HP (0.45 pf)	UL 1054 - Horsepower- 6,000 operations
250 VAC	-	-	¼ HP (0.45 pf)	UL 1054 - Horsepower- 6,000 operations
250 VAC	16	6	-	EN.60158-1 T85 (°C) 50,000 operations
400 VAC	16	4	-	EN.60158-1 T140 (°C) 10,000 operations
0-15 VDC	10	-	-	General rating - 50,000 operations
15-30 VDC	7	-	-	General rating - 50,000 operations

## Operating Characteristics

Actuator	Reference	Actuating Force		Release Force		Free Position Maximum		Operating Position		Total Travel Position Maximum		Over travel	
		(N)	(ozf)	(N)	(ozf)	(mm)	(in)	(mm)	(in)	(mm)	(in)	(mm)	(in)
Straight plunger	XP2Z11	3,00	10,0	5,5	19,7	15,3	0,602	14,9 ± 0.4	0,587 ± 0.016	8,0	0,315	4,5	0,177
	XP42Z11	1,75	6,20	5,5	19,7	15,3	0,602	14,9 ± 0.4	0,587 ± 0.016	8,0	0,315	6,5	0,256
	XP52Z11	3,00	10,0	5,5	19,7	16,6	0,653	13,0 ± 0.4	0,511 ± 0.016	8,0	0,315	4,5	0,177
Mushroom plunger with reset spring	XP2E1Z11	6,5	23,3	9,0	32,3	15,3	0,602	14,9 ± 0.4	0,587 ± 0.016	10,5	0,413	2,1	0,082
	XP42E1Z11	3,75	13,4	9,0	32,3	15,3	0,602	14,9 ± 0.4	0,587 ± 0.016	10,5	0,413	4,0	0,157
	XP52E1Z11	6,5	23,3	9,0	32,3	16,6	0,653	13,0 ± 0.4	0,511 ± 0.016	10,5	0,413	2,1	0,082
Mushroom plunger	XP2E2Z11	3,0	10,0	5,5	19,7	15,3	0,602	14,9 ± 0.4	0,587 ± 0.016	8,6	0,339	4,0	0,157

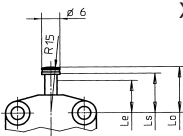
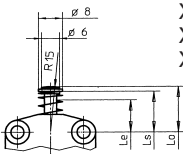
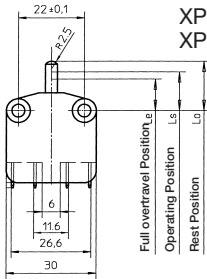

## Ordering Reference

Basic type	XP XPS	Momentary Positive action forced break (normally closed only)	Example: XP	2	2	E1	Z11
Circuit	2 4 5	Change-over Normally closed Normally open					
Terminals	2	Faston 6,3 × 0,8					
Actuators	E1 E2	No symbol, straight plunger Mushroom plunger with reset spring Mushroom plunger					
Approvals	Z11	UL, cUL, CSA and ENEC					

## XT

Characteristics ■ 8 mm contact gap 8 mm creepage and clearance distances  
 ■ forced double break contacts

Rating 400 VAC, 16,5 A max.

Dimensions (mm) 30 × 32 × 12

Actuator ■ shrouded plunger  
 ■ optional key  
 ■ plain plunger

Approvals UL, cUL, CSA, ENEC



## Preferred Range

Ordering Reference	Actuating Force (N)	Actuating Force (ozf)	Operating pos. (mm)	Operating pos. (in)	Terminal	Circuit	Actuator	Contacts	Electrical rating
XTD22AZ1	3,8	13,6	13,0	0,511	Faston	NO	Plunger	Ag nickel	Up to 400 VAC, 16.5 A

## Specifications

Housing	Glass fibre reinforced polyester
Plunger	Glass fibre reinforced polyester
Mechanism	Normally open
Contacts	Silver nickel
Terminals	6.3 mm (0.25 in) faston - brass
Temperature range °C	-20°C to +85°C
Mechanical life	10 <sup>6</sup> cycles minimum (impact free actuation)
Protection	IP40 (enclosure)
Mounting	Snap-on or screw mounting
Actuator	Plunger (can be held depressed for maintenance with optional key shrouded option only)
Accessories	<b>Maintenance key N41784</b> and multiplug housing XTMHSG

Circuit diagram

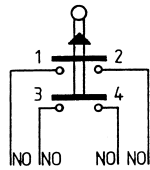

Dimensions

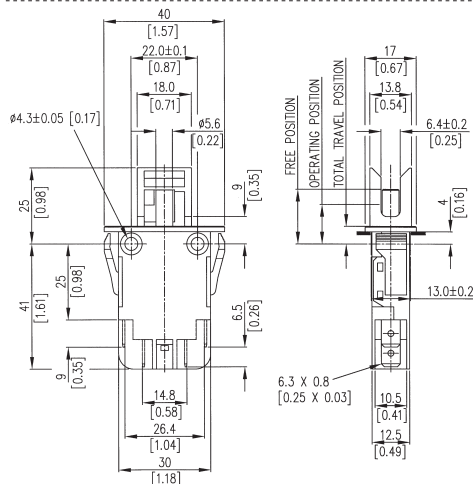

SNAP MOUNTING DETAILS

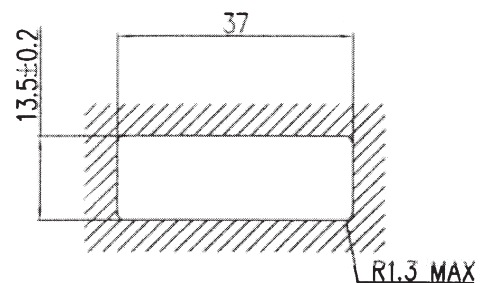

PANEL THICKNESS 1.0 – 2.5

## Recommended maximum electrical ratings

Voltage (max)	Load (A)	Inductive load	Horsepower	Approval
125 VAC	15.5 (0.75 pf)	-	-	UL 1054/CSA 22.2 No. 55 - 100,000 operations
250 VAC	15.5 (0.75 pf)	-	-	UL 1054/CSA 22.2 No. 55 - 100,000 operations
125 VAC	-	-	½ HP (0.45 pf)	UL 1054 - Horsepower- 100,000 operations
250 VAC	-	-	½ HP (0.45 pf)	UL 1054 - Horsepower- 100,000 operations
125 VAC	-	-	1½ HP (0.45 pf)	UL 1054 - Horsepower- 100,000 operations
250 VAC	-	-	1½ HP (0.45 pf)	UL 1054 - Horsepower- 100,000 operations
30 VAC	0,5	-	-	EN.60158-1 T85 (°C) 50,0000 operations
400 VAC	16,5	8	-	EN.60158-1 T85 (°C) 50,0000 operations
30 VDC	0,5	-	-	UL 1054/CSA 22.2 No. 55 - 6,000 operations

## Operating Characteristics

Actuator	Reference	Actuating Force Maximum		Release Force Minimum		Free Position Maximum		Operating Position		Total Travel Position Maximum		Over travel	
		(N)	(ozf)	(N)	(ozf)	(mm)	(in)	(mm)	(in)	(mm)	(in)	(mm)	(in)
Plunger	XTD22AZ1	3,8 (± 0.5)	13,600 (± 3.5)	5,8	20,8	18,0	0,708	13,0 ± 0.4    0,511 ± 0.016		10,0    0,394		3,0    0,118	
								(main contact)					
								12,6    0,496					
								(low voltage contact)					

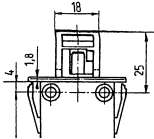

## Ordering Reference

Basic type	XTD	Example: XTD	22	J	Z1
Terminals	22 A	6.3 × 0.8 mm faston terminals 100 k operations at 15:5 A 250 VAC, UL114 478			
Form	- J P K	Without identification: snap-on mounting with shroud Snap-on mounting without shroud Without shroud, without snap-on mounting			
Approvals	Z1	UL, cUL, CSA and ENEC			

# Auto Power-Off



Circuit diagram

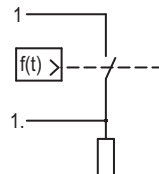

Dimensions

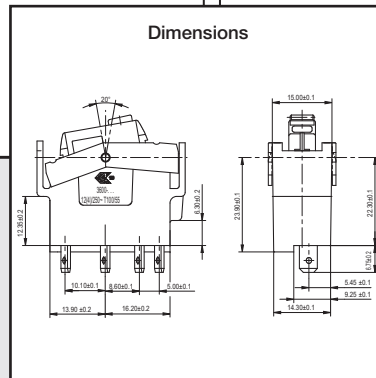

# TIPPMATIC® Auto Power-Off Series



## TIPPMATIC® Exceeds the requirements of European Ecodesign Directive

Main applications	Coffee machines Small domestic appliances
Characteristics	<ul style="list-style-type: none"><li>■ single pole on/off power switch</li><li>■ auto power-off function embedded</li><li>■ manual shut-off at any time</li><li>■ illuminated or non-illuminated</li><li>■ contact gap 3 mm</li><li>■ tracking resistance PTI 250</li><li>■ glow wire test 850 °C &amp; compliant to IEC 60335-1, 4 ed.</li><li>■ faston terminals 4.8 x 0.8 mm</li><li>■ snap-in mounting</li><li>■ compatible to rocker switch series 3680</li></ul>
Rating	250 VAC, 12(4) A      T100/55 125 VAC, 15 A        T100 125 VAC, 12 A        T100
Dimensions (mm)	38 x ~32 x ~17
Actuator	<ul style="list-style-type: none"><li>■ standard rocker 25.4 x 10.7 mm</li><li>■ customized actuators on request</li></ul>
Approvals	ENEC, cULus

## Product line

### TIPPMATIC® Timer

Ideal for small appliances & filter coffee machines

- auto power-off switch with integrated timer electronics
- complete range of shut-off times to meet any requirements



### TIPPMATIC® iF

Ideal for small appliances & automatic coffee machines

- auto power-off switch with integrated interface
- shut-off signal to be provided externally from appliance's control unit



### TIPPMATIC® Plus

Ideal for small appliances & automatic coffee machines

- auto power-off switch with integrated driver unit & interface
- shut-off signal to be provided externally from appliance's control unit



### TIPPMATIC® iPlus

Ideal for small appliances, filter & automatic coffee machines

- auto power-off switch with microcontroller, driver unit & interface
- microcontroller supports customized features



# TIPPMATIC® Timer

## Specifications

- Switch type: Rocker switch with auto power-off function
- Features: Single pole on/off  
 Power switch with integrated solenoid & timer electronics  
 27 shut-off times ranging from 30 secs. to 20 h  
 Start-up time of electronics ~5 sec.  
 0-voltage function – shut-off in case of mains power failure  
 Bulb for illumination

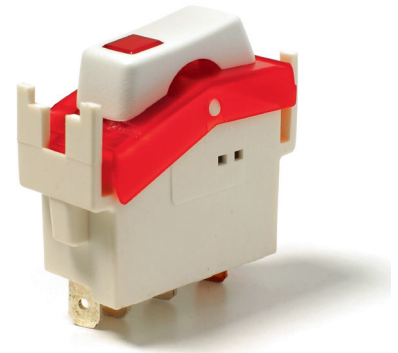

Circuit diagram

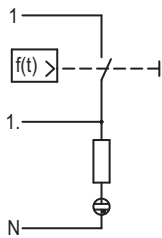

Dimensions

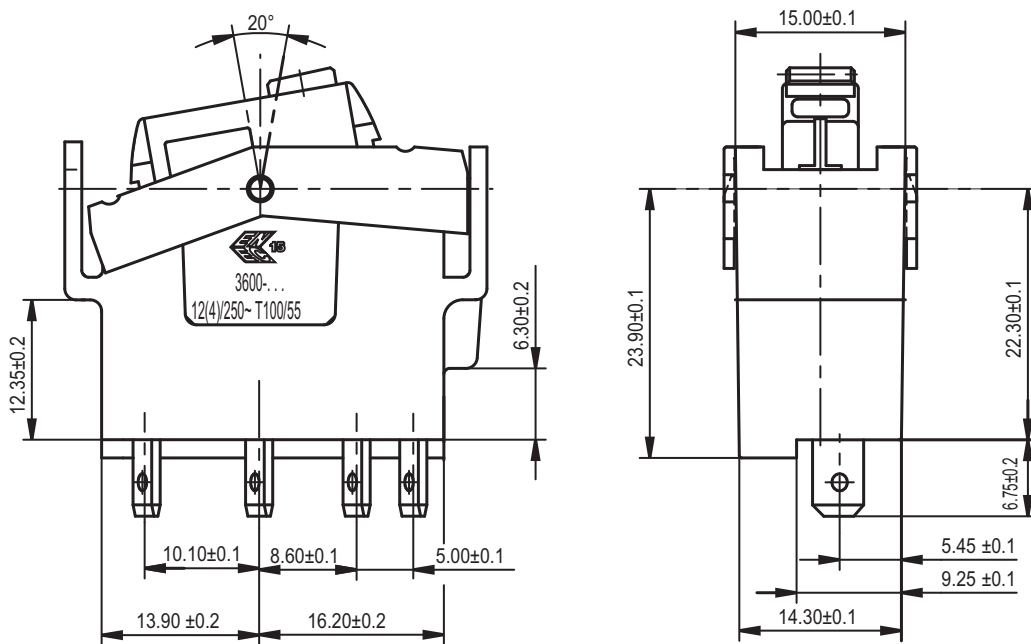

## Standard range switches

Ordering Reference	Illumination	Terminals 4.8	Time delay		Approvals	
			(50 Hz)	(60 Hz)	(ENEC)	(cUL)
3600-411.27 1552	yes	tab 4,8 mm	15 min.		250 VAC 12 (4) A	
3600-412.28 1552	yes	tab 4,8 mm	30 min.		250 VAC 12 (4) A	
3600-414.27 1552	yes	tab 4,8 mm	120 min.		250 VAC 12 (4) A	
3600-512.40 1542	yes	tab 4,8 mm		25 min.		125 VAC 15 A

Auto Power-Off

## Specifications

- Switch type Rocker switch with auto power-off function
- Features Single pole on/off  
 Power switch with integrated solenoid  
 Interface for connection to appliance's control unit  
 Auto shut-off signal to be provided by external signal  
 Signal 16-22 VDC, 3 msec. max. pulse time  
 0-voltage function – shut-off in case of mains power failure  
 Bulb for illumination

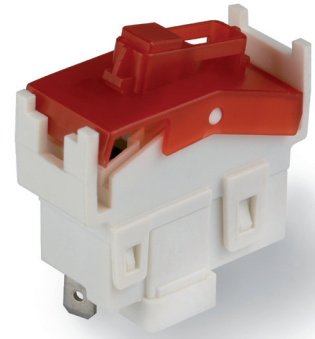

Circuit diagram

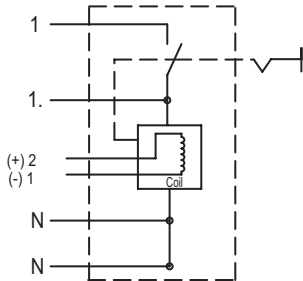

Dimensions

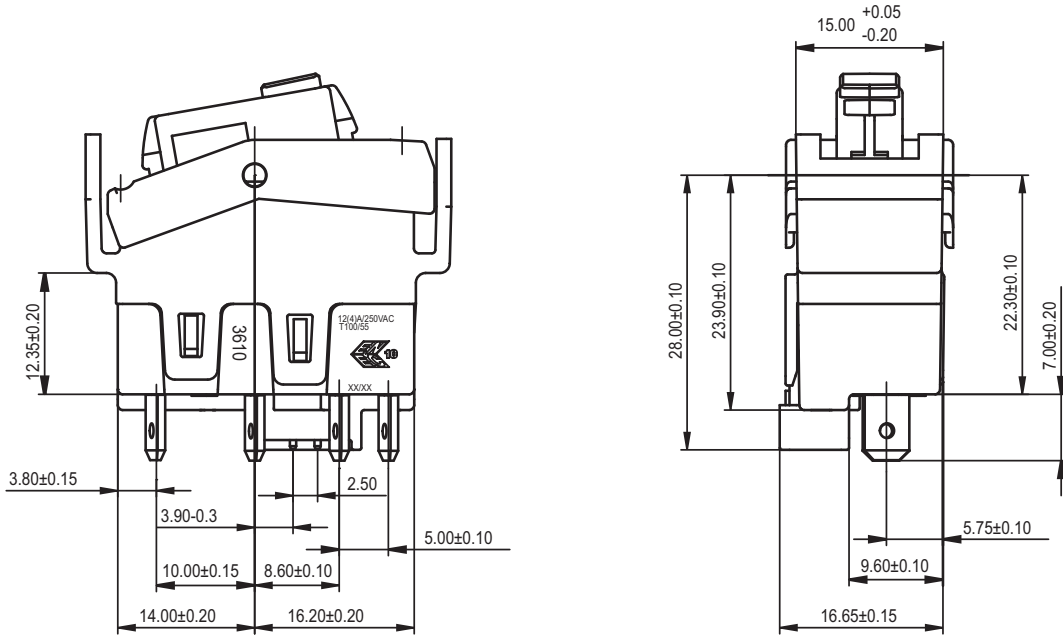



# TIPPMATIC® Plus

## Specifications

- Switch type Rocker switch with auto power-off function
- Features
- Single pole on/off
  - Power switch with integrated solenoid & driver unit
  - Interface for connection to appliance's control unit
  - Signal overload protection system
  - Auto shut-off signal to be provided by external signal
  - Signal 5 VDC, 3 msec. max. pulse time
  - Start-up time of electronics ~5 sec.
  - 0-voltage function – shut-off in case of mains power failure
  - Bulb for illumination

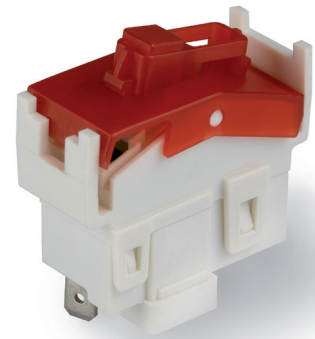

Circuit diagram

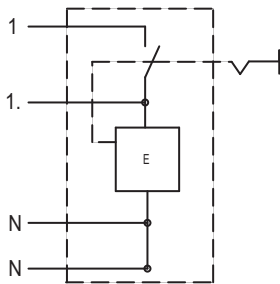

Dimensions

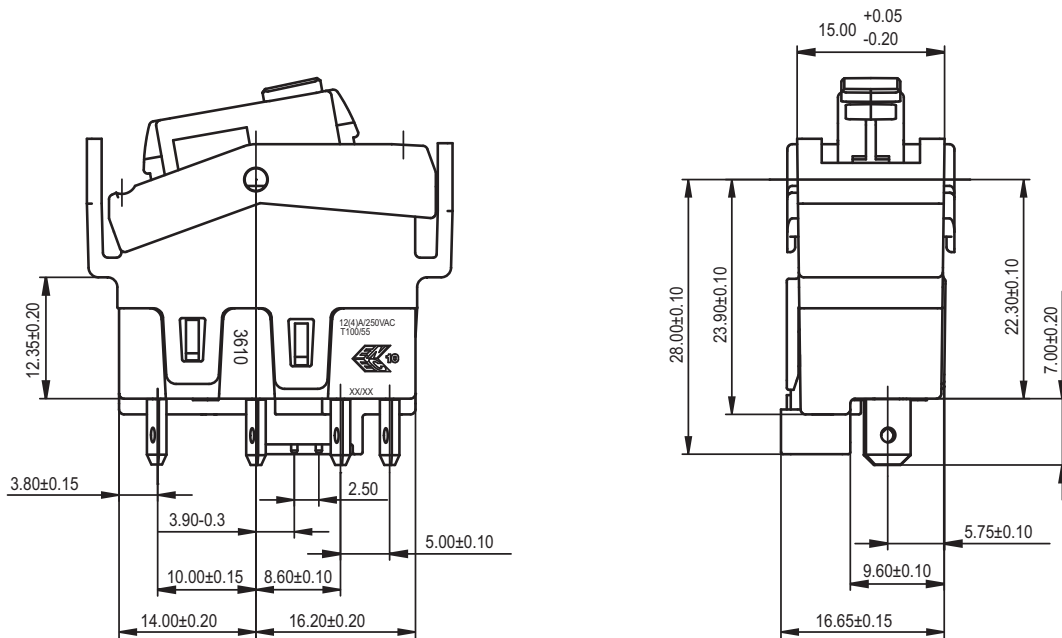

## Specifications

Switch type	Rocker switch with auto power-off function
Features	<p>Single pole on/off</p> <p>Power switch with solenoid, driver unit &amp; microcontroller</p> <p>Interface for connection to appliance's control unit</p> <p>Auto shut-off signal to be provided by external signal</p> <p>Analog or digital shut-off signal, 5VDC max</p> <p>Internal microcontroller supports customized features, typical functions are reservoir level indication, temperature, lime-scale, brew unit position etc.</p> <p>Start-up time of electronics ~5sec.</p> <p>0-voltage function – shut-off in case of mains power failure</p> <p>LED for illumination &amp; signal indication</p>

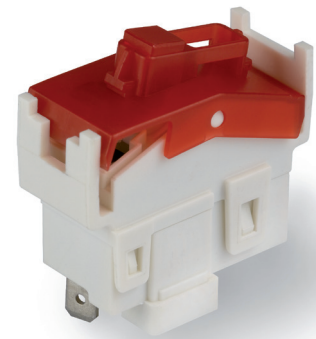

Circuit diagram

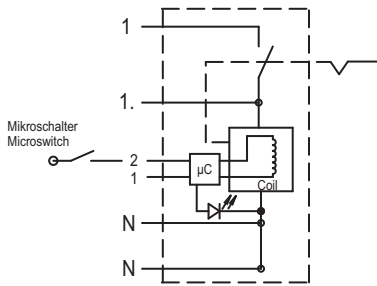

Dimensions

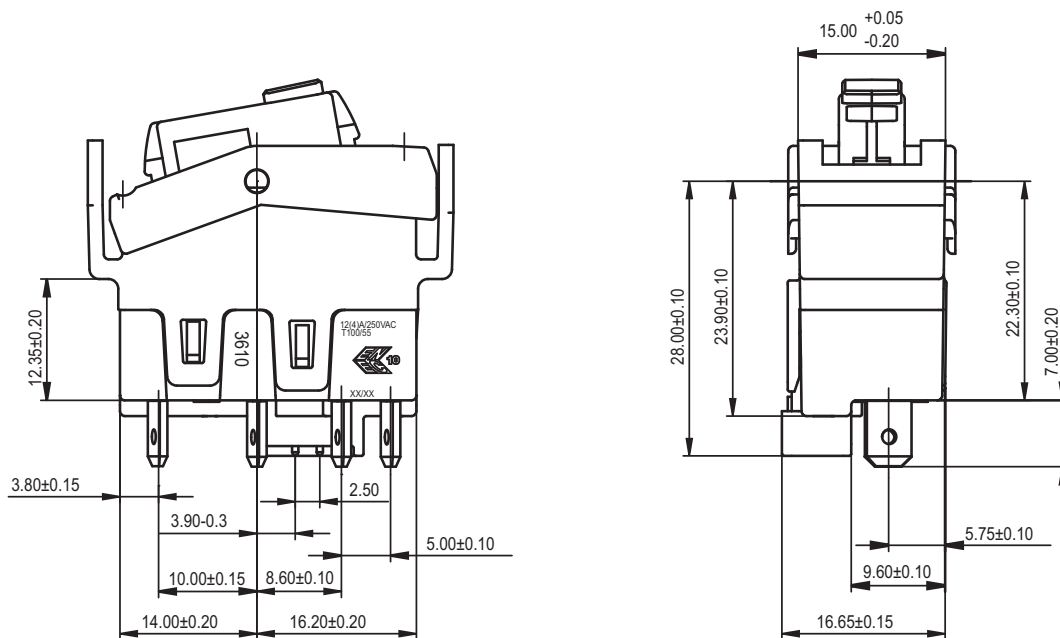

# TIPPMATIC® Auto Power-Off Series



## TIPPMATIC®

### Exceeds the requirements of European Ecodesign Directive

Main applications	Appliances & coffee machines Washer, dryer, dishwasher
Characteristics	<ul style="list-style-type: none"><li>■ single pole on/off power switch</li><li>■ double pole on/off switch (TIPPMATIC iFD Double Disconnect)</li><li>■ auto power-off function embedded</li><li>■ zero stand-by power consumption</li><li>■ manual shut-off at any time</li><li>■ illuminated as on option</li><li>■ contact gap 3 mm</li><li>■ tracking resistance PTI 250</li><li>■ glow wire test 850 °C &amp; compliant to IEC 60335-1, 4 ed.</li><li>■ PCB terminals</li></ul>
Rating	250 VAC, 12(4) A T100 125 VAC, 12 A T100 250 VAC, 13 A T85 100 VAC, 13 A T85
Dimensions (mm)	TIPPMATIC iF 25 x 40 x 13
Actuator	<ul style="list-style-type: none"><li>■ plunger</li><li>■ customized actuators on request</li></ul>
Approvals	ENEC, cULus

## Product line

### TIPPMATIC® Timer

#### Ideal for small appliances & filter coffee machines

- auto power-off switch with integrated timer electronics
- complete range of shut-off times to meet any requirements



### TIPPMATIC® iF

#### Ideal for appliances, automatic coffee machines, washer, dryer, dishwasher

- auto power-off switch with integrated interface
- shut-off signal to be provided externally from appliance's control unit

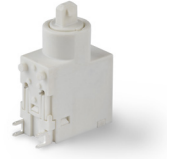

### TIPPMATIC® Plus

#### Ideal for appliances, automatic coffee machines, washer, dryer, dishwasher

- auto power-off switch with integrated driver unit & interface
- shut-off signal to be provided externally from appliance's control unit



### TIPPMATIC® iPlus

#### Ideal for appliances, automatic coffee machines, washer, dryer, dishwasher

- auto power-off switch with microcontroller, driver unit & interface
- microcontroller supports customized features



### TIPPMATIC® iFD Double Disconnect

#### Ideal for automatic coffee machines, washer, dryer, dishwasher

- auto power-off switch with integrated interface
- shut-off signal to be provided externally from appliance's control unit
- programmable control option

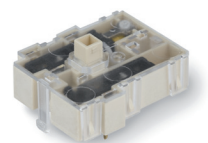

# TIPPMATIC® Timer

## Specifications

- Switch type Push button switch with auto power-off function
- Features Single pole on/off  
Power switch with integrated solenoid & timer electronics  
27 shut-off times ranging from 30 secs. to 20 h  
Start-up time of electronics ~5 sec.  
Shut-off in case of mains power failure (0-voltage function)

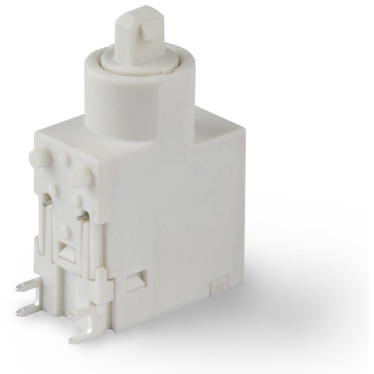

Circuit diagram

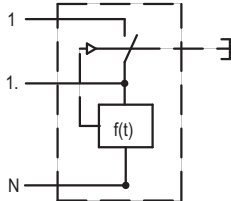

Dimensions

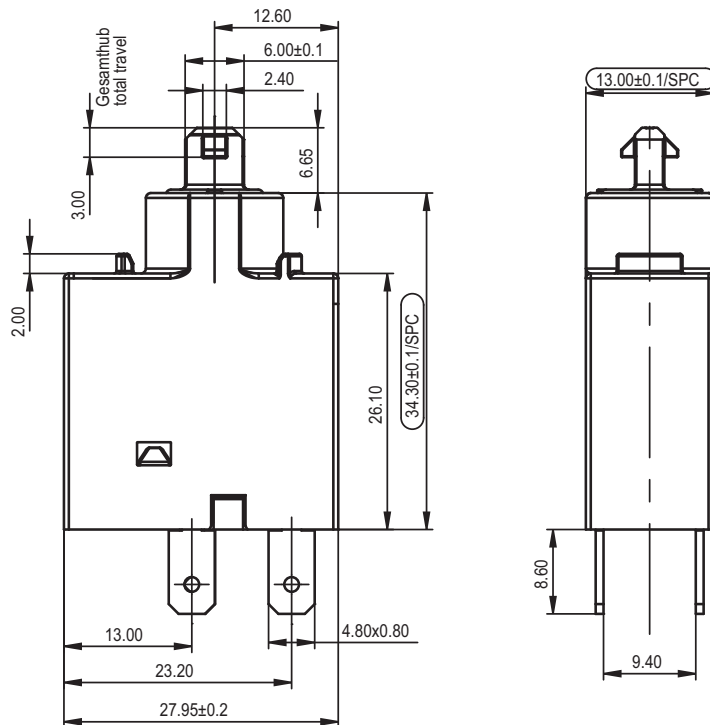
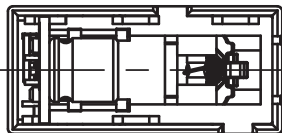

## Specifications

Switch type	Push button switch with auto power-off function
Features	Single pole on/off Power switch with integrated solenoid Interface for connection to appliance's control unit Auto shut-off signal to be provided externally Signal 16-22 VDC, 3 msec. max. pulse time

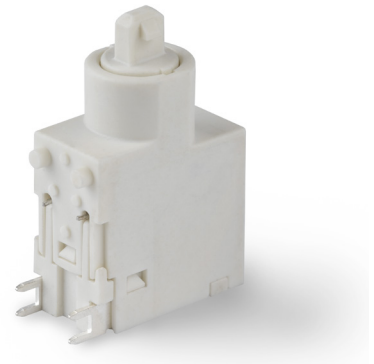

Circuit diagram

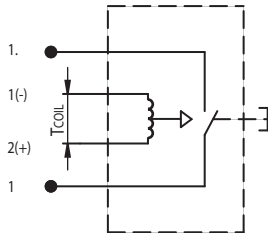

Dimensions

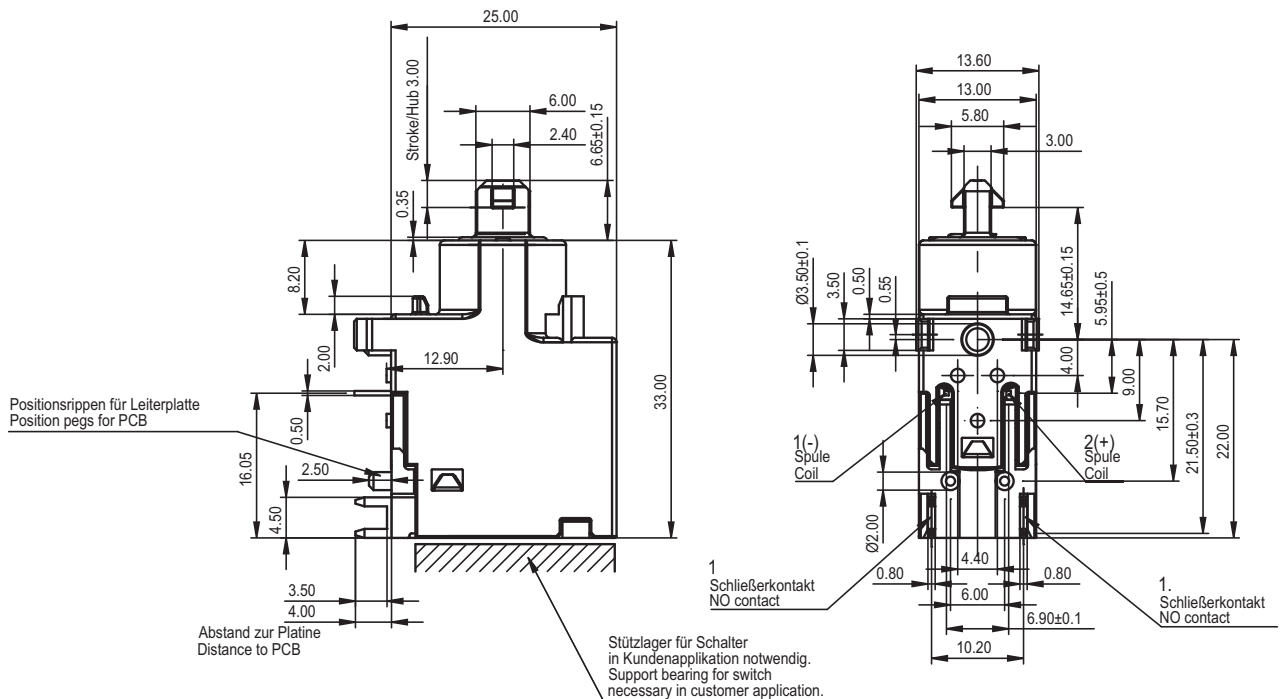

# TIPPMATIC® iFD Double Disconnect

## Specifications

Switch type	Push button switch with auto power-off function
Features	Double pole on/off Power switch with integrated solenoid Interface for connection to appliance's control unit Auto shut-off signal to be provided externally Signal 16-22 VDC, 3 msec. max. pulse time Programmable control option Start-up time of electronics ~5 sec. Shut-off in case of mains power failure (0-voltage function) Dimensions 44 x ~36 x ~14 mm

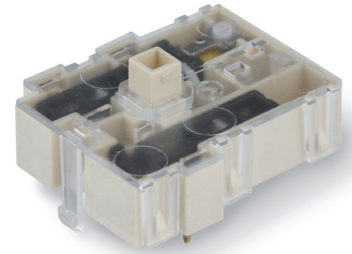

Circuit diagram

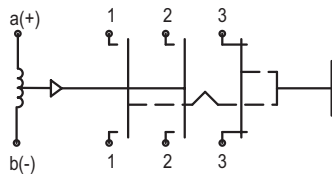

Dimensions

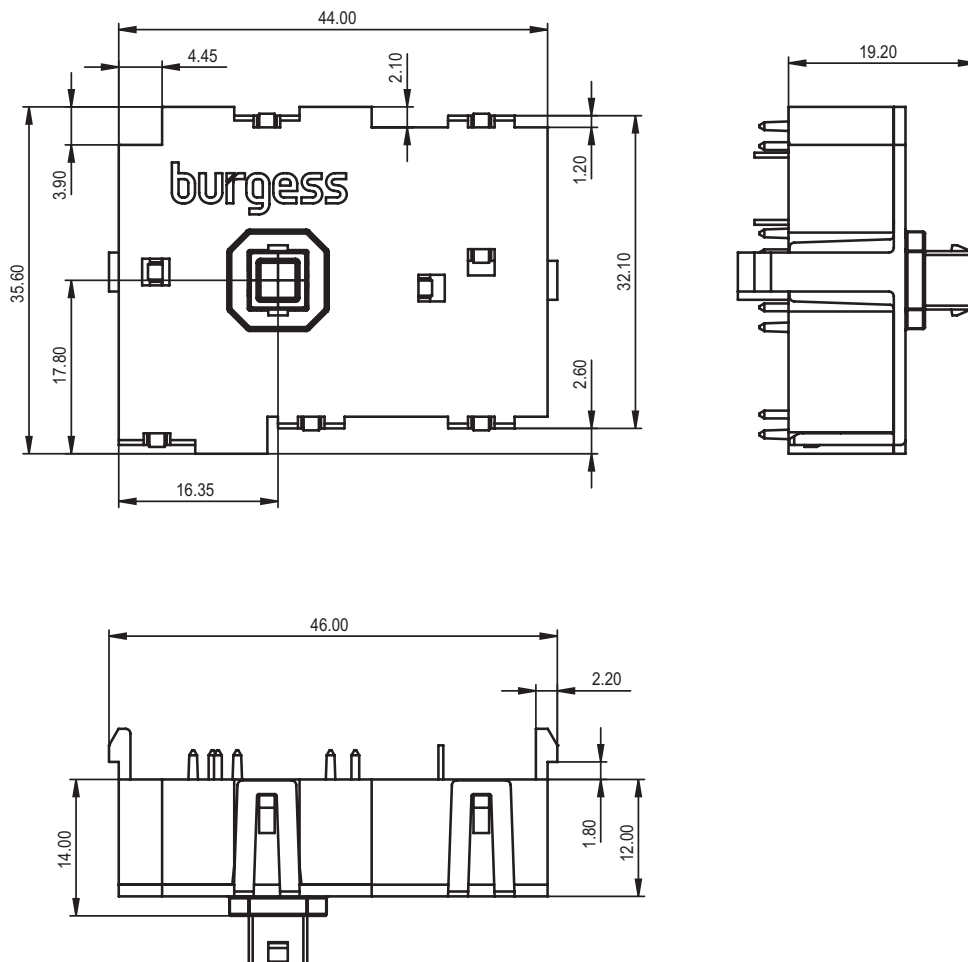

# Table of preferred products

Snap-action Microswitches	Type	Preferred Products	Preferred Products	Page
Ultraminiature	F1	F1T8GPUL	F1T8Y1GPUL	17
	F4	F4T7UL F4T7GPUL F4T7Y1UL	F4T7Y1GPUL F4T7YCUL F4T7YCGPUL	20
	F5	F5T8UL F5T8GPUL F5T8Y1UL	F5T8Y1GPUL F5T8YCUL F5T8YCGPUL	23
	F1NS	F1NST8 F1NST8A1	F1NST8AC	26
	L16	L16T8		29
	FK4	FK4T7UL FK4T7Y1UL	FK4T7YCUL	32
Subminiature	V4L	V4LS V4LSA1 V4LSA2	V4LST7 V4LST7A1 V4LST7A2	36
Miniature sealed	V3NS	V3NSUL V3NSY1UL V3NSYRUL V3NSYR1UL V3NSYCUL	V3NST1UL V3NST1Y1UL V3NST1YRUL V3NST1YR1UL V3NST1YCUL	41
	V3S	V3SUL V3SYRUL	V3SYR1UL V3SY1UL	44
Standard	3BR	3BR103	3BR510	47
Metal housed	V9N	V9N V9NLR V9NLR1 V9NL V9NML V9NV	V9NLRV V9NLR1V V9NLV V9NMLV V9NMVR V9NMLRV	50
	4BR	4BR	4BR510	54
Miniature	BVM3	BVM3FULS BVM3FYULS	BVM3FYRULS	58
	KB5	KB5FULS KB5FKULS	KB5FKRULS	61
Forced break	XP	XP2Z11 XP4Z11 XP5Z11 XP2E1Z11	XP4E1Z11 XP5E1Z11 XP2E2Z11	65
	XT	XTD22AZ1		68