



Witold Ślirz, Grzegorz Dąbrowski,
Grzegorz Jasiński, Łukasz Baran

TESTING SAFETY OF ELECTRICAL DEVICES

TESTING ELECTRICAL DEVICES IN VIEW OF STANDARDS AND CODES
USING PAT-800 AND PAT-805 METERS



Spis treści:

1.	Introduction	3
2.	Testing electrical equipment in view of standards and codes	3
3.	Classification of electrical equipment.....	5
4.	Test intervals	5
5.	Testing power tools	7
5.1	Scope of tests	7
5.1.1	Visual inspection	7
5.1.2	Idle run test	9
5.1.3	Testing the PE conductor.....	9
5.1.4	Testing insulation resistance.....	12
5.1.5	Testing leakage current.....	15
5.1.6	Power, current drawn and voltage measurement.....	19
6.	Testing extension cords and IEC cables.....	19
7.	Testing welders	20
7.1	Standards and codes	20
7.2	Scope of tests.....	21
7.2.1	Visual check	21
7.2.2	Testing the PE conductor	21
7.2.3	Measuring insulation resistance	21
7.2.4	Testing leak current.....	23
8.	Sonel S.A. PAT-800 and PAT-805 meters.....	24
9.	Accessories for Sonel S.A. PAT-8xx meters.....	29
10.	Recording and documentation of tests with Sonel PAT software	32
11.	Summary	39

Appendix 1

Example of testing electrical appliances in an EU country with ambiguously defined norms (Poland)	40
---	----

1. Introduction.

In our daily lives, we are surrounded with Electrical devices; testing of these devices periodically is important to maintain the efficiency of equipment and to ensure the safe operation of the equipment. While using the equipment, it is important to realize the threats involved with the incorrect operation of the equipment.

Each Electrical Equipment Manufacturer is obliged to design and Manufacture their products according to standards ensuring the safe and efficient operation.

During the manufacturing process of the equipment, equipment manufacturers carry out so called „TYPE TEST“ to confirm compliance with valid safety standards. But the safety cannot be guaranteed during operation, on according with various situations like breakdown of insulation part etc...

Therefore, bearing in mind many doubts regarding the requirements and methods for testing electrical devices for safety, we have decided, based on our experience, legal requirements and expert knowledge, to release a publication which compiles sufficient information to let those responsible for technical condition of electrical equipment organise their knowledge in this field.

This publication describes risks involved in bad technical condition, provides a classification of electrical devices, methods and test intervals and statutory requirements for carrying out such tests. At the end of the work, measuring instruments and tools for documentation and equipment database management are described.

2. Testing electrical equipment in view of standards and codes.

Many individuals find it difficult to specify standards or legal acts related to periodic testing of the electrical devices. First of all, this applies to power tools, since in different EU countries there are different regulations and in some they are ambiguous. The example of this is European Norm 60745-1, which relates to type tests and testing of products made by tools manufacturers, without any mention of operating tests.

Note that not only power tools should be tested. Extension cords, office and kitchen equipment or production machines are equally prone to damage.

Information regarding operation, maintenance and tests can be found in the user's manual but, as the practice shows, all that can be found there is a brief note on the obligatory care and testing technical condition, or even no manual is enclosed at all. It will also be difficult to collect and read instructions for e.g. several dozen various devices from different manufacturers.

What then? There is a duty to follow the generally accepted technical rules. It is not a mistake to apply standards compulsory in other countries, such as DIN VDE 0701 -0702 (VDE 0701 -0702): 2008-06 Prüfung nach Instandsetzung, Änderung elektrischer Geräte - Wiederholungsprüfung elektrischer Geräte, especially because the measuring instruments for such measurements use, in most cases, test procedures developed based on the German or British standards.

Provisions obligatory in EU countries, govern the design, operation, maintenance of electrical equipment and authorisation to operate and perform periodic testing.

They state explicitly that the owner (company owner, home user) is entirely responsible for safe use of machinery and equipment. In order to find out if the devices are safe, regular checks and tests have to be performed based on the approved subject-related standards.

The Labour Code

In case of work tools, among other things:

- 1) an employer shall ensure that the machines and other technical equipment used provide safe and healthy working conditions, in particular, protect the worker from injury, electric shock.
- 2) it is not allowed to equip workplaces with machinery and other technical equipment, which does not conform to the safety requirements.
- 3) the obligation to meet safety requirements is also on the machinery, equipment and other products' manufacturer, as well as on the purchaser of foreign licenses or machinery, devices and other imported products.
- 4) this obligation also applies to the user of the machinery, devices or other products.
- 5) the tools and protective equipment should undergo periodic testing in the scope provided by the manufacturer's documentation, regulations and should be permanently marked with the id number, date of the next periodic test and designation mark. It is prohibited to use equipment or tools which are not marked.

STANDARDS CONCERNING SAFETY OF ELECTRICAL APPLIANCES

DIN VDE 0701-0702 (VDE 0701-0702): 2008-06 Prüfung nach Instandsetzung, Änderung elektrischer Geräte – Wiederholungsprüfung elektrischer Geräte.

DIN VDE 0751:2001 Wiederholungsprüfungen und Prüfungen vor der Inbetriebnahme von medizinischen elektrischen Geräten oder Systemen.

EN 60745-1:2003 Electrically powered hand held tools- Operating safety – Part 1. General requirements (superseded 02 PN-88/E-08400).

EN 60745-1:2003 Operating safety of electrically powered hand held tools. Part 1: General requirements.

EN 60950:2002 Safety of IT equipment.

EN 60990:2002 Methods for measuring the touch current and protective wire current.

EN 62353 Medical electrical equipment - Periodic inspection and testing after repair of medical electrical equipment.

IEC 60601 Medical electrical equipment.

EN 60974-4: 2009 Arc welding equipment. Part 4: Inspection and testing in operation.

3. Classification of electrical equipment

The table below classifies electrical devices for their uses and places them against the corresponding standards.

	Start up and modifications	Tests after servicing				Periodic testing							Type tests/ procedural tests				
		DIN VDE 0701:0702	DIN VDE 0751:2001	EN 62353	IEC 60601	DIN VDE 0701:0702	PN-88E-08406:1988	DIN VDE 0751:2001	British Standards	EN 62353	IEC 60601	PN-EN 60974-4	DIN EN 60950/50116	DIN EN 61010	DIN EN 60335/50106	PN-EN 60745-1	IEC 60601
Equipment tested to standards	DIN VDE 0751:2001																
Laboratory equipment		●				●			●								
Measuring equipment		●				●			●				●				
Voltage generating equipment		●				●			●								
Electrical tools		●				●	●		●						●	●	
Heating equipment		●				●			●						●		
Electrically-powered tools		●				●	●		●						●	●	
Lights		●				●			●						●		
Multimedia and telecom equipment		●				●			●						●		
Cable drums, extension cords, connecting cables		●				●			●						●		
Data processing equipment and office equipment		●				●						●					
Electrical equipment for medicine, part of applications	●		●	●	●			●		●	●						●
Welding equipment											●						

Table 1. Type of devices tested – Tests – Standards and codes.

4. Test intervals.

To begin, note that it is the user to decide about test intervals. Many companies have their quality systems implemented, which specify the procedures for recording and testing electrical safety of equipment.

Frequent testing of such equipment improves their operating safety, yet it increases the operating cost. Therefore, in case of a large number of devices, it is worth to classify them for particular uses.

The regulations compulsory in different EU countries are slightly different, however most of them define necessity of performing the following tests.

There are two types of tests:

- a) **current tests** - perform each time before putting a power tool into operation, and for tools classified under the 2nd and 3rd category (see section 5), before starting each shift. The current tests include visual check and checking operation in idle.

b) periodic tests – should be performed at least:

- every 6 months for power tools category 1;
- every 4 months for power tools category 2;
- every 2 months for power tools category 3;
- after each event that could affect the operation.

Broader classification with the relevant intervals has been published by IEE, and prepared by the British Institution of Electrical Engineers (IEE, <http://www.iee.org>).

Place of use	Device type	Tested by the user – note 2	Class I		Class II	
			Visual check – note 3	Check and measurements – note 5	Visual check - Note 3	Check and measurements - Note 5
Industry, commercial facilities, kitchen	S IT M P H	Every week Every week Before use Before use	- - Once a month Once a month Once a month	Every year Every year Every year Every 6 mths Every 6 mths	- - Every quarter Every quarter Every quarter	Every year Every year Every year Every 6 mths Every 6 mths
Equipment for public use	S IT M P H	Note 6+ Note 6+ Note 6+ Note 6+ Note 6+	Once a month Once a month Every week Every week Every week	Every year Every year Every 6 mths Every 6 mths Every 6 mths	Every quarter Every quarter Once a month Once a month Once a month	Every year Every year Every year Every year Every year
Schools	S IT M P H	Every week + Every week + Every week + Every week + Before use+	- - Every 4 mths Every 4 mths Every 4 mths	Every year Every year Every year Every year Every year	Every year Every year Every 4 mths Every 4 mths Every 4 mths	Every 4 years Every 4 years Every 4 years Every 4 years Every 4 years
Hotels	S IT M P H	- - Every week Every week Before use	Every 2 years Every 2 years Every year Every year Every 6 mths	Every 4 years Every 4 years Every 2 years Every 2 years Every year	Every 2 years Every 2 years Every 2 years Every 2 years Every 6 mths	- - - - -
Offices and shops	S IT M P H	- - Every week Every week Before use	Every 2 years Every 2 years Every year Every year Every 6 mths	Every 4 years Every 4 years Every 2 years Every 2 years Every year	Every 2 years Every 2 years Every 2 years Every 2 years Every 6 mths	- - - - -
<p>1. S Stationary. IT IT equipment. M Equipment not connected permanently, up to 18 kg, e.g. welder. P Portable equipment up to 18 kg, e.g toaster, kettle. H Hand tools, e.g. drill, dryer.</p> <p>2. Inspection results are not recorded unless damage occurred.</p> <p>3. The visual check should be included in the tests, and the results of measurements should be recorded.</p> <p>4. If the device class is unknown, it should be treated as the class 1 device.</p> <p>5. The results of checks and measurements should be recorded.</p> <p>6. Some devices require checks everyday.</p> <p>+ inspector/instructor/member</p>						

Table 2. Classification of equipment and test intervals developed by the British Institution of Electrical Engineers

5. Testing power tools.

Power tools can be divided in terms of:

a) **operation categories** (the way they are used):

Category I - power tools operated occasionally, several times during a shift, returned to the rental or having the same users.

Category II - power tools operated frequently during one shift and handed over to other shifts without being returned.

Category III - power tools operated continuously during one or more shifts, or installed permanently, e.g. in a production or assembly line.

The operation category is crucial for the scope and frequency of testing and measurements of the power tools. The previous section provides testing intervals for individual device groups.

b) **protection classes** – the way the equipment is made in terms of fire protection:

Class I - in addition to the basic insulation, all metallic parts are connected with PE protection wire in such a manner that, in the event of insulation damage, they may not become live.

Class II - power tools without the PE protection wire, but double, or reinforced insulation is required in addition to the basic one. With proper insulation, the enclosure can also be made of metal.

Class III - power tools of this class are supplied by circuits with very low voltage, the value of which may not exceed:

- 50V (AC) or 120V (DC) - in normal conditions;
- 25V (AC) or 60V (DC) - in case of more hazardous conditions;
- 12V (AC) or 30V (DC) - in case of special hazards.

5.1 Scope of tests.

5.1.1 Visual inspection

The visual inspection of a device tested is the first step in correct evaluation of its technical condition. The inspection is made with the use of simple tools. The scope of the inspection is often determined by the type of device tested. The scope of an **external inspection** includes:

a) **checking the device identification plate**

The identification plate provides details of important features of the device tested. The basic features are: name, type, insulation class, rated voltage, serial number.

If no plate is present, the device should be permanently marked with at least an unique identification number. Device that cannot be identified will not be approved for use.

b) **checking the power supply cord and plug**

Particular attention should be drawn to the condition of the cord insulation: make sure if

the dirt does not deteriorate it or if there are no cracks. If no original plug is installed, verify if it conforms to the safety class, and if its tightly and safely attached.

The power supply cord includes: phase (L), neutral (N) and protective conductor (PE) for 1 class devices. Individual conductors should have different insulation colours:

- phase conductor L – brown or black;
- neutral conductor N – blue;
- protective conductor PE, neutral and protective PEN – 2 colours, green and yellow.

This colour coding should be present on the entire wire length, and only on conductors used for electric shock protection.

c) checking the enclosure

Make sure if the enclosure is complete, free from cracks and dirt affecting the operating safety (e.g. grease).

d) operation of mechanical parts, switches, regulators, interlocks

Pay special attention to parts crucial for the safety, e.g. interlocks and switches. The switches should operate smoothly and act at the first attempt.

e) checking enclosure bolts

Check for completeness and tightening. If not original, make sure the bolts do not protrude outside the enclosure and if they securely hold the parts.

f) checking guards and seals

Some devices are provided with sealing parts, e.g. for use in dusty atmospheres. It is important to check condition of those components to ensure safety during operation. Check guards, if any, for completeness and if they are movable, check for proper operation and secure fitting.

g) checking ventilators

To ensure proper operation of drive components, check ventilator holes for blocking and remove dust if necessary.

The internal checks (requiring partial disassembly) include:

a) testing power supply cord for secure fitting, and connections inside the device and plug.

Pay particular attention to check if the conductors inside the device are secured with a clamp protecting from pulling out and the conductor connection for optimum area. Also check the condition of conductor insulation at the terminal, darkened or hardened insulation may indicate contact overheating (poor contact or prolonged overload).

b) checking the PE protective conductor, its connections and protective terminals.

The PE conductor should be slightly longer so that, when pulled, it was not the first to be disconnected. Check insulation colour and for secure connection..

c) checking connections and contacts of all components included in the device electrical circuit (switches, regulators, capacitors)

d) checking commutator and brushes

Check brushed for length, the surface of commutator and sparking of the brushes with the device powered. Some devices come with reinforced insulation in a form of insulation screen mounted in the commutator area. Check it for damage due to high temperature and electric arc from the commutator.

e) checking rotor and stator winding

Check for visible overheated winding (darker insulation colour and specific smell as that of dried plums).

f) checking bearings, mechanical systems and ventilation

5.1.2 Idle run test

The idle run is checked after powering the device on. This is to check the device operating parameter against its ratings. Check for abnormal noise in the mechanisms, bearings, sparking of commutator brushes. The test should take several seconds.

5.1.3 Testing the PE conductor

The PE conductor is tested in the 1 protection class devices. The measurement is taken between the protective contact of the plug (or connection point in case of devices connected permanently) and metallic parts of the enclosure connected with the PE wire.

Resistance of the PE conductor is a sum of several components:

- resistance of the power core,
- resistance of the connectors,
- resistance of the extension cord (if exist).

Standard	Test current	RPE limit of a protective conductor up to 5 m long, in Ω
VDE 0701-0702	200mA	0,3
British standard	10A, 25A	0,2
EN 61010		
EN 60335		
EN 60950		
PN-88 E-08400/10	25A	0,1

Table 3. PE conductor measuring conditions.

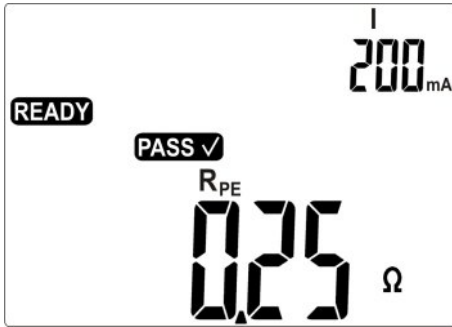

Correct result: $R_{PE} < LIMIT$

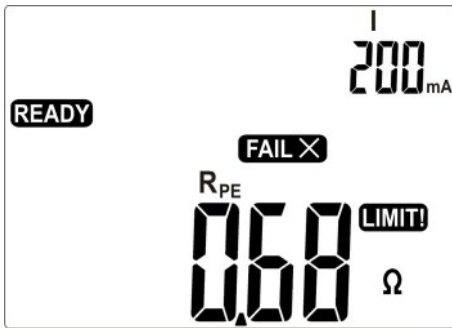

Incorrect result: $R_{PE} > LIMIT$

Fig. 1. PE conductor test of different equipment with PAT- 800/805 meter

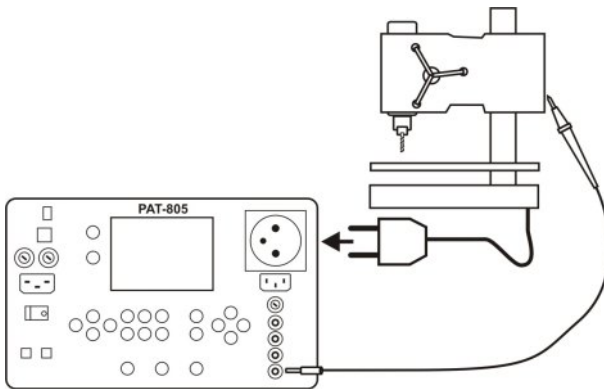

Fig. 2. Testing PE conductor continuity (200mA two-wire method) – measuring system as of PAT-800/805

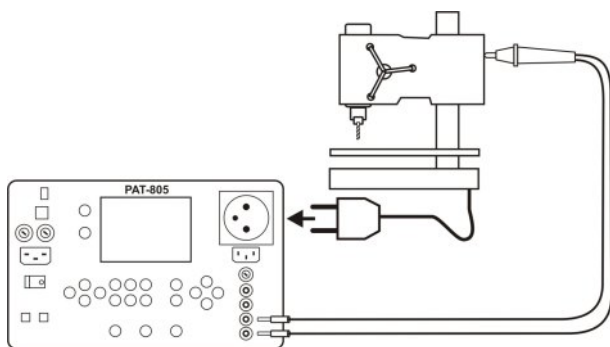

Fig. 3. Testing PE conductor continuity (10/25 A three-wire method) – measuring system as of PAT-805

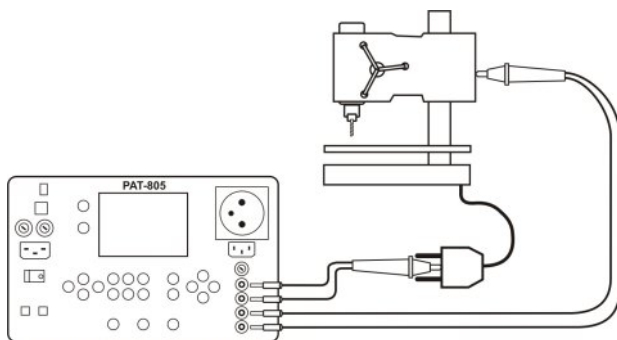

Fig. 4. Testing PE conductor continuity (10/25 A four-wire method) – measuring system as of PAT-805

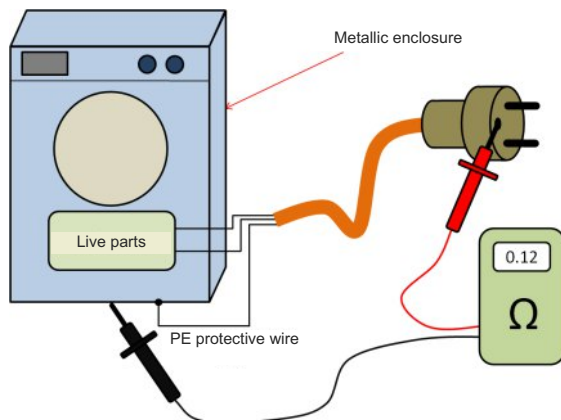

Fig.5. Testing PE conductor continuity – measuring system schematic diagram

5.1.4 Testing insulation resistance

Proper insulation resistance is crucial for the operating safety of devices. It should be measured together with the power supply cord. According to the standards among others: British, German, it should be measured with test voltage 500 V with the measuring current 1 mA. The measuring time should be at least 60 seconds. The test is done between shorted L-N wires and the exposed metallic parts of the enclosure. Check not only the main components but also any bolts, terminals or other metallic parts. It might occur that a bolt, e.g. after mounting device holder, damages the live conductor insulation and becomes live.

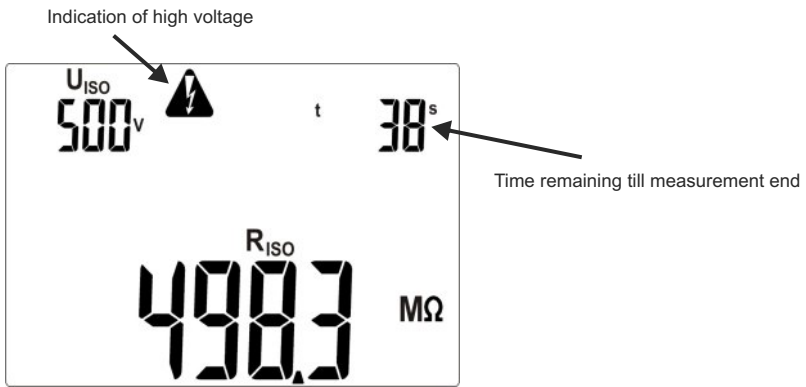

Fig. 6. Testing insulation resistance of various devices with PAT-800/805 meter.

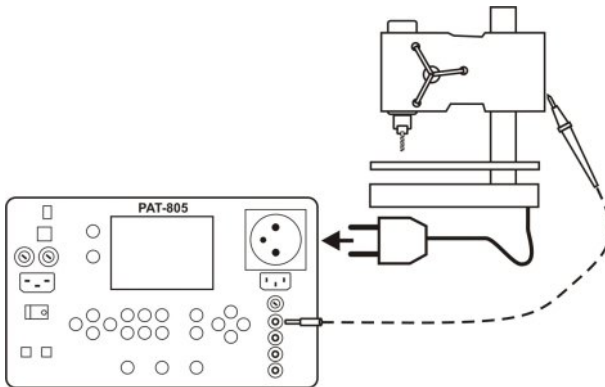

Fig. 7. Testing insulation resistance in class 1 device – measuring system as of PAT-800/805

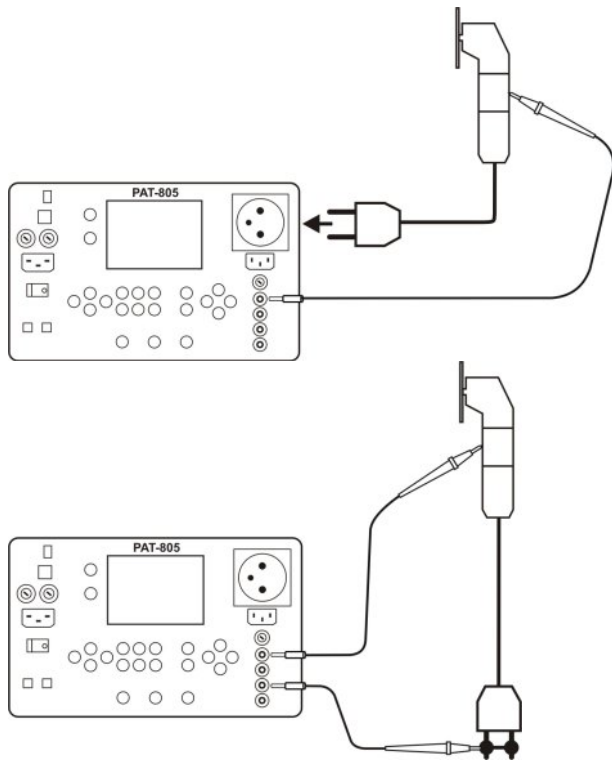

Fig. 8. Testing insulation resistance in class 2 or 3 device – measuring systems as of PAT-800/805 using RISO- and RISO+ measuring sockets

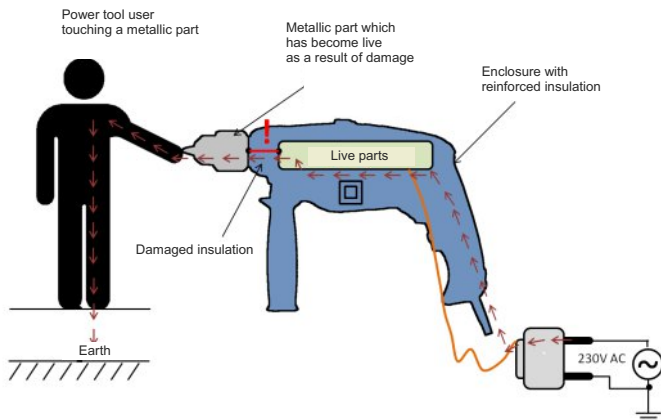

Fig. 9 Example of damaged insulation in a class 2 device

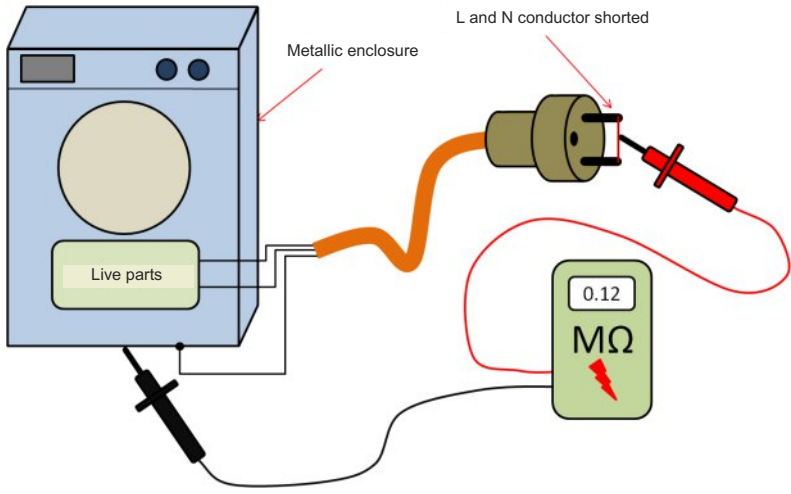

Fig. 10. Example of measuring insulation resistance in a class 1 device

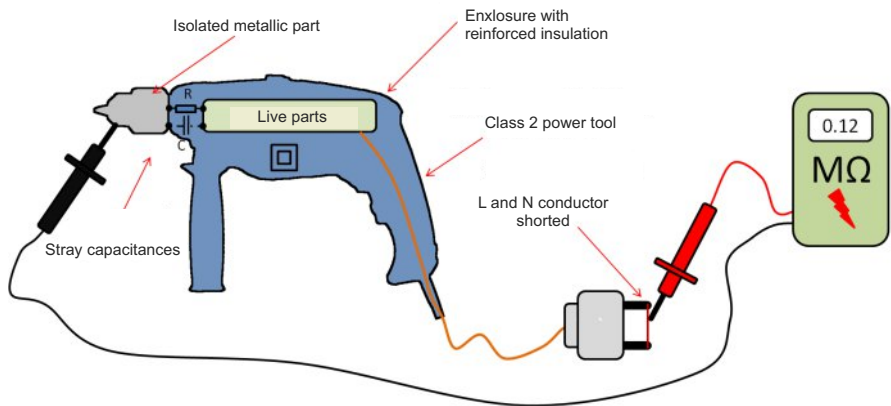

Fig. 11. Example of measuring insulation resistance in a class 1 device

In order to measure resistance of insulating parts, they can be wrapped with aluminium foil on the entire area. For better conductivity, a moist piece of cloth can be placed between the foils and enclosure part.

The table below shows limit values of insulation resistance and the scope of tests depending on the protection class of the device being tested.

DIN VDE 0701-0702		
Between live parts and exposed metallic parts.	I	1
	II	2
	III	0,25
	Heating equipment	0,3
Insulation tested	Protection class	Resistance limit in MΩ
Recommended in many countries		
Between live parts and exposed metallic parts.	I and III	2
	II	7
Between live parts and metallic parts separated from live parts only with basic insulation.	II	2
Between metallic parts separated from live parts only with basic insulation and exposed metallic parts.	II	5

Table 4. Resistance limit for various standards.

5.1.5 Testing leakage current

Leakage current flows from live parts, through insulation, to earth. The leakage current includes: current flow through the insulation and capacitances in the device (among others from filtering or control systems).

Leakage current affects operating safety and, sometimes, causes interference within the power grid.

German and British standards specify the leakage current limit and conditions for tests. Particular attention require testing in case of severe conditions, heavy dustiness or high humidity.

According to DIN VDE 0701-0702, the maximum leakage current should not exceed 1 mA for class 1 devices, and 0.5 mA for 2 class devices. Note also that the limit values do not apply to heating equipment with power rating above 3.5 kW.

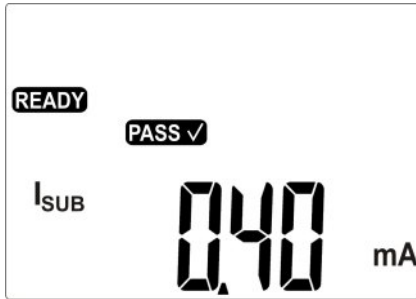

Correct result: $I_{SUB} < LIMIT$

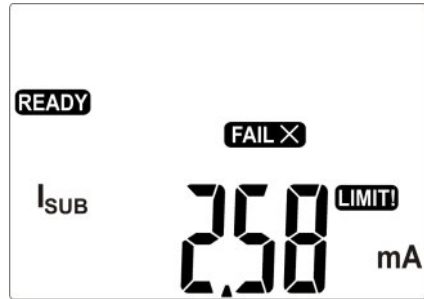

Incorrect result: $I_{SUB} > LIMIT$

Fig. 12. Testing leakage current with PAT-800/805 meters.

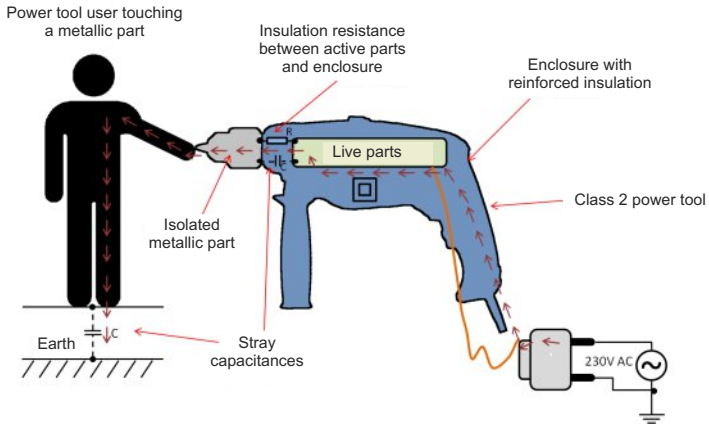

Fig. 13. Example of touch leakage current in a class 2 device.

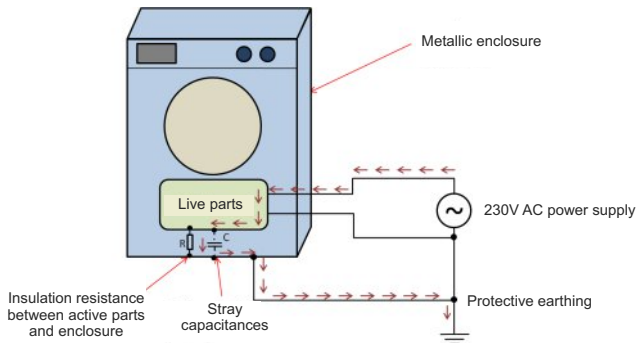

Fig. 14. Earth electrode leakage current (PE) example in a class 1 device.

The measurements of leakage current include the following:

- slope leakage current

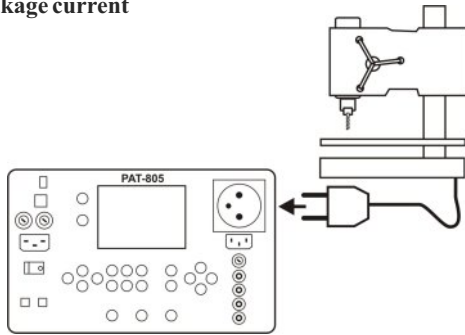

Fig. 15. Measuring slope current in a class 1 device.

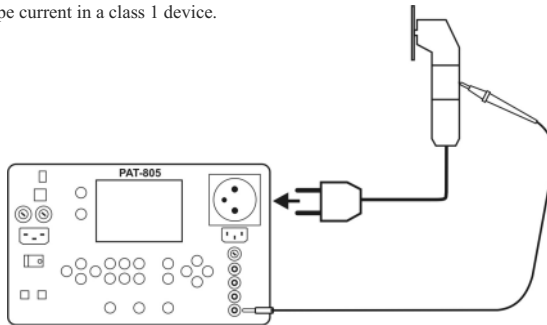

Fig. 16. Measuring slope current in a class 2 device.

The meter indicates measured voltage between shorted L and N of the device tested and PE, in case of class 1 devices, or probe in case of class 2 devices. The measurement is taken at the voltage 25 – 50 V, and the current measured is scaled proportional to the value that would occur at the nominal voltage supplying the device. The measuring circuit is galvanically separated from the grid and the PE wire.

- earth electrode leakage current (PE):

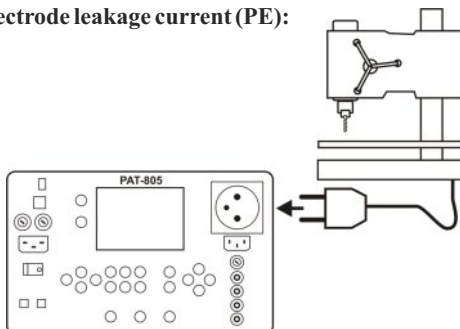

Fig. 17. Measuring earth electrode current (PE) in a class 1 device.

During such measurement, with a built in ammeter, current flowing in the PE conductor of the device tested is measured. The leakage current in the PE is measured directly in that line, thus it can be accurately measured, even if the device draws 10A or 16A. Note, however, that if the leak flow is not to the PE or not only to the PE, and to other earthed parts of the device being tested (e.g. water pipe), it will not be indicated in this measuring function.

- differential leakage current:

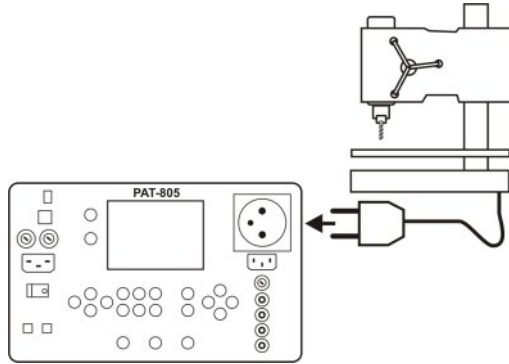

Fig. 18. Measuring differential current.

Differential leakage current is measured as a difference between the L and N conductor current for devices of all protection classes. This measurement includes the current leaking not only through PE (class 1 devices), but also through other earthing parts, e.g. water pipe. The measurement result is a sum of all leaks in the device.

- touch leakage current

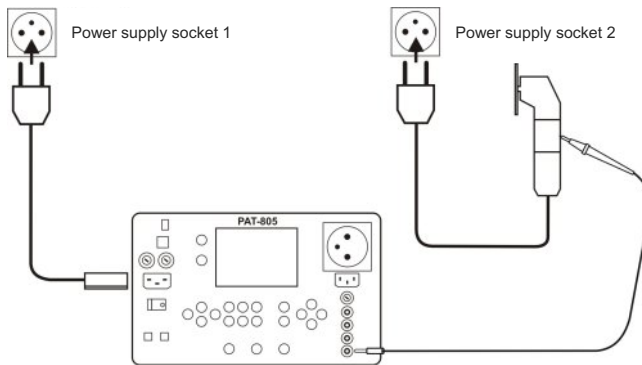

Fig. 19. Touch current measurement

The measuring range results from the measuring circuit used, with the corrected touch current simulating human sensing and reactions, according to EN 60990. This is distinguished, among others, by that the internal probe resistance equals 2 k Ω .

5.1.6 Power, current drawn and voltage measurement

This is the measuring function which allows checking a device operating in idle or loaded condition. During such measurement, the meter shows current values of:

- voltage between power conductors U_{LN} ;
- load current I_a ;
- apparent power;
- measurement duration.

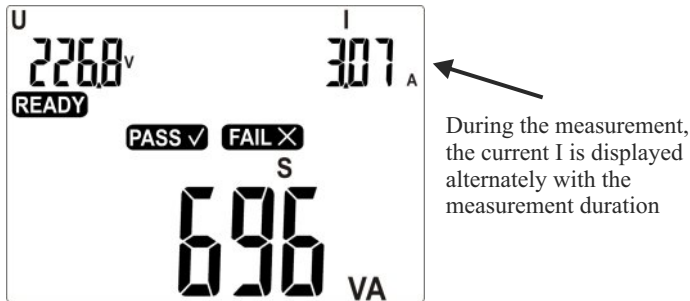

Fig. 20. Measurement of power, current and voltage with the example of PAT-805 meter

6. Testing extension cords and IEC cables

An extension cord is a section of electrical conductor intended for increasing the operating range of other electrical equipment.

Extension cords may be either simple, limited to a short cable terminated with a plug or socket, or more complex with the length of several tens metres, drum, cassette, sockets and also have a residual current device or filtering units. This also applies to power cords detachable from the powered equipment.

PE extension cord is a portable device exposed to damage, especially when used at construction sites or in other severe conditions. Apart from mechanical impacts, damage may also be caused by e.g. high external temperature or internal overheating due to high current flow. Extreme temperatures are the major cause of deterioration. Therefore extension or power supply cord should be frequently tested.

Many devices are provided with detachable power cords, which should be tested as the extension cords.

As in the case of power tools, an important part of the test is the visual check.

Condition of the cable, plug and sockets should be checked. It is vitally important to check the contacts of the plug and sockets inside the extension cord. As a result of high current flow, the contacts become degraded. On this occasion, check bolts holding the wire for tightening.

After the visual check perform electrical safety tests, including the following: testing PE resistance and insulation resistance, checking polarisation of conductors.

The minimum resistance of PE wire, according to DIN VDE 0701-0702 should be 0.3Ω for extension cords up to 5 m. For longer cords, the limit resistance can be increased by 0.1Ω per each 7.5 m (above 5 m). The resistance, however, should not exceed 1Ω .

If the extension cord comes with an RCD, check also its parameters. The results of testing insulation and leak current are the same as in the case of testing equipment (see the previous section).



Fig. 21. Testing an extension cord with the PAT-805 meter

7. Testing welders

Welders are devices operating based on the principle of exchanging electric energy into a stream of heat energy, capable of melting metallic parts locally. The welders, for the method of energy exchange, are divided as follows:

- arc welders;
- plasma welders;
- resistance welders;
- laser welders;
- electron welders.

7.1 Standards and codes

In August 2009, the EN 6074-4 “Equipment for arc welding”. Part 4: Checks and operating tests” standard was released. That standard was superseded in August 2011 by Part 4: "Periodic checks and testing". This standard describes procedures for operating tests, after maintenance and servicing, to ensure operating safety.

Due to the fact that most of the activities in testing welders is similar to those for testing other equipment (power tools), the following is an overview of activities specific for that devices.

7.2 Scope of tests

7.2.1 Visual check

The visual check of a welder should include:

- electrode holder and welding current return terminal;
- power supply cord and plug;
- welding circuit;
- enclosure;
- controls and indicators;
- and all other parts affecting operating safety.

Results of the check should be recorded in a test report.

7.2.2 Testing the PE conductor

Continuity of the PE circuit is checked between the plug protective contact and exposed metallic parts of the welder.

Resistance of the PE circuit should not exceed 0.3Ω . If the supply cord is longer than 5 m the value of this resistance increased with 0.1Ω per each 7.5m of the cord.

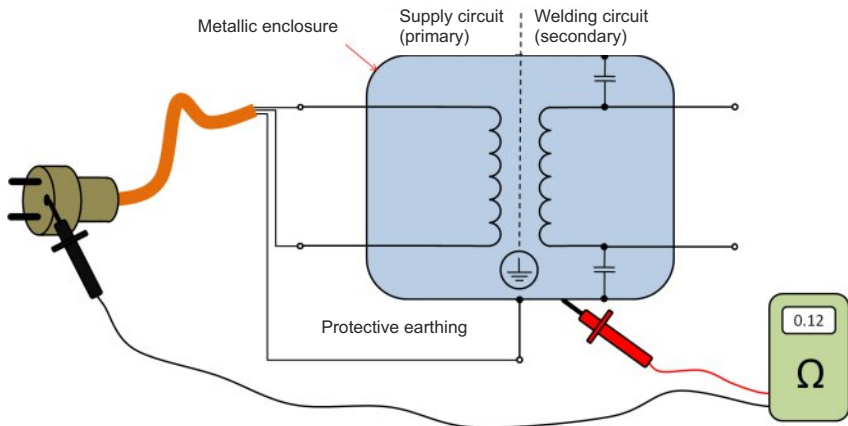

Fig. 22. Testing PE conductor resistance in a welder

7.2.3 Measuring insulation resistance

Insulation resistance is measured with the voltage of 500 V, with the holders disconnected, in 3 systems:

- between the supply circuit and welding circuit (insulation resistance limit $5 M\Omega$):

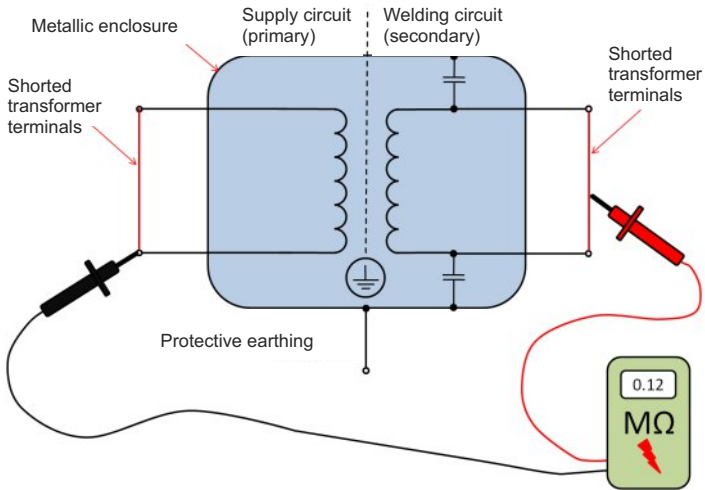

Fig. 23.

- between the welding circuit and protective conductor (insulation resistance limit 2.5 MΩ):

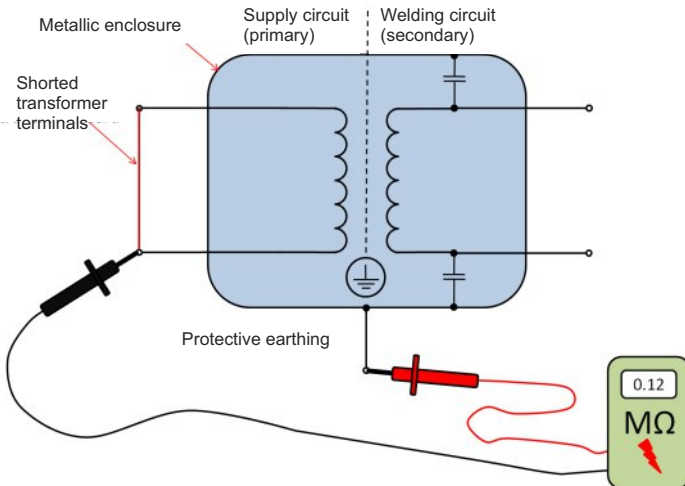

Fig. 24.

- between the supply circuit and protective conductor (insulation resistance limit 2.5 MΩ):

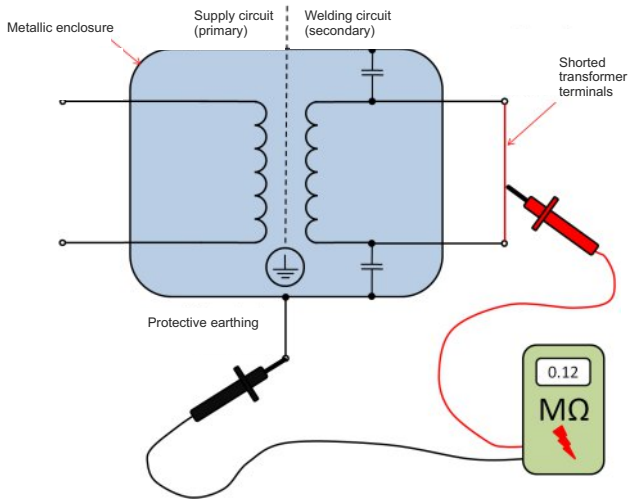

Fig. 25.

7.2.4 Testing leakage current

Welding circuit leakage current.

The leakage current between welding holders and protective conductor terminal should not exceed 10 mA AC.

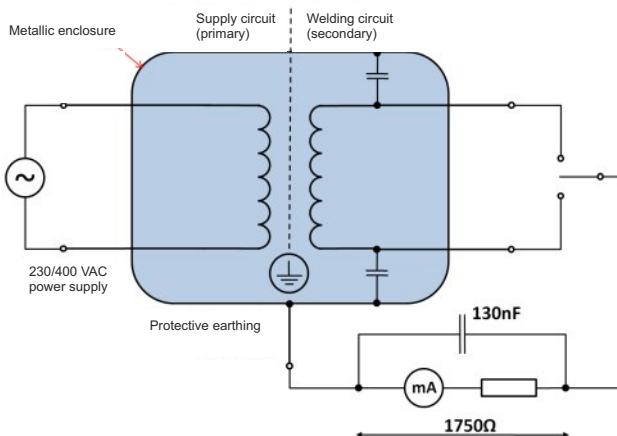

Fig. 26. Testing welding leakage current

Primary circuit leakage current.

The primary leakage current in the external protective circuit should not exceed:

- 5 mA for welders with rated current for plugged connections up to 32 A;
- 10 mA for welders with rated current for plugged connections above 32 A;
- 10 mA for welders with permanent connection;
- 5 % of the rated input current per phase, for welders with permanent connection and reinforced protective conductor.

Test conditions:

- welding energy source is insulated from earth;
- welding energy source is supplied with rated voltage;
- welding energy source is connected to protective earthing only through the measuring circuit;
- the input circuit is in no-load condition;
- filtering capacitors should be disconnected.

Voltage in no-load condition.

Peak values of the maximum voltage in no-load condition, at all possible settings, should not exceed the values given on the identification plate, if the energy source is supplied with the rated voltage and frequency.

The no-load voltage is measured between the output welding terminals. If, for safety and control reasons, this is impossible (e.g. for welding energy sources for plasma cutting), the no-load voltage is measured between the holder and welding return lead terminal.

Compliance should be verified by measuring:

- a) rms values;
- b) peak values.

8. Sonel S.A. PAT-800 and PAT-805 meters

Manufacturers of measuring equipment developed special appliances for testing safety of electrical equipment. In the Western European countries they are referred to as PAT - Portable Appliance Testing.

They are usually used for testing protective conductor (circuit), insulation resistance, leak currents and to perform functional tests, i.e. measuring power and other parameters during operation.

On choosing a testing device the following should be noticed:

1. Whether it has the memory function.

The memory makes the work much easier. Measurement data series are stored together with a description of the device tested. When downloaded in a PC afterwards, the data can be easily processed and presented in a form of a report.



Fig. 27. PAT-800.

2. Measuring sequence (auto-test) function.

Measuring sequences allow automated work. On starting a sequential test, the device will activate, step by step, the following (pre-programmed) measuring functions to inform the user on the activities to be performed during the following tests.



Fig. 28. PAT-805.

3. Testing scope.

In the market, both simple and advanced measuring devices are available. The price is often crucial for the choice, yet, before the final decision is taken, consider the following:

- number of devices and testing frequency;
- type of devices tested – some require special accessories and measuring functions;
- device compliance with the national regulations;
- does the device really comply with its specifications? It often happens in all types of measuring devices that there are significant discrepancies. For example, the measuring current values specified (e.g. R_{PE} 25 A) are maintained only in case of shorted measuring circuit. Connecting any load (tested object) causes drastic decrease of this current, which is due to low efficiency of measuring transducers and measuring circuits.

PAT-800 and PAT-805 meters are designed for testing power tools, household appliances and IT equipment. They are enclosed in a sealed, handy suitcase.

Everyone using a device for testing safety of electrical devices, while deciding whether or not to approve the tested equipment for use, assumes great responsibility for life, health and property of the users. Sonel's key objective while developing PAT-800 and PAT-850 meters was to create devices which would ideally perform in such situation and meet all relevant requirements.

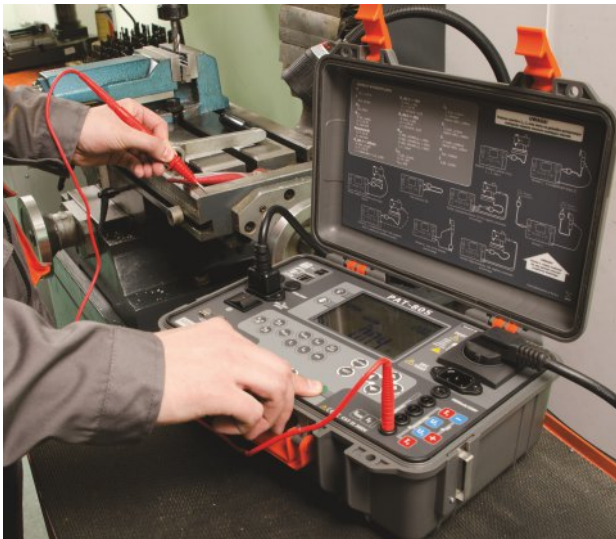

Fig. 29. Measuring with PAT-805

Functionality and technical parameters of Sonel meters allow full control of technical condition of electrical appliances and tools, and also testing basic parameters of three-phase equipment. Furthermore, to ensure operating safety and correct readings PAT-800 meters, immediately after power on, test parameters of the power supply system (i.e. voltage, frequency, continuity and voltage in the protective conductor). The meters allow testing in automatic mode, where customised measuring sequences can be set for the selected parameters, or in manual mode. The manual mode is controlled with function selector buttons, without the need to go through any additional menu. PAT-805, for example, allows full testing procedure including:

Initial test, inspection of the device tested. The meters initially check continuity of the L-N circuit and allow testing a fuse. PAT devices also show, on the display, the moment when a visual check of the tested equipment should be performed – this option is possible during the initial and auto-test.

Measuring resistance of earthing conductor (PE) with the current 200 mA (PAT-800, PAT-805) and 10A or 25A (PAT-805). In case of 200 mA, it is possible to perform auto-zeroing of the measuring leads to eliminate further measurement error. In case of 10 and 25 A measurements, it is not necessary. Sonel adopted a professional solution here (four-wire measurement), to ensure high measurement resolution, 1 m Ω with maximum error elimination. An advanced current setter is a highly efficient solution, **ensuring maximum current >25 A, up to 0.2 Ω , which is currently impossible in many often high-range meters currently available in the market.** Furthermore, continuity measurements can be performed using a measuring socket or with the cables themselves, which allows testing of cables and equipment without power plug.

Insulation resistance measurement. Three measurement voltages available: 100V (PAT-805), 250V (PAT-805) and 500V (PAT-800, PAT-805), as well as a broad measuring range allow selection of proper measurement parameters for a wide range of tested devices. In addition to that, the meters have measuring input protection against hazardous voltage on the object being tested. There are two ways to perform the measurements, using a measuring sockets, or with the leads only.

Measuring leakage currents. Sonel PATs offer as much as **four functions** for measuring: slope leakage current, differential leak current, touch leakage current and PE leakage (earth) current. The measurements are made for a broad range of frequencies of leakage current (e.g. 20 Hz ... 100 kHz, for PE leak current and touch current).

Measuring power, functional test. While testing electrical equipment, it often becomes necessary to check if a given device draws the power assumed by the manufacturer. PAT-800 and PAT-805 allow not only measurement of the power drawn, in the range up to 3.9 kVA, but they also display current and voltage.

IEC cable and extension cord tests. Automatic meters check the main parameters of IEC cables and also, with a special adapter, extension cords and cables with IEC-60320-C5 connector (so called “Mickey Mouse”, used e.g. in laptop power supplies). Measuring sequence is performed automatically and includes: measurement of insulation resistance of protective conductor, measurement of PE wire resistance (continuity), testing continuity of L and N conductors, and checking for short circuits between them and polarisation check.

In all measuring functions, where necessary, simple setting of the measurement duration and result limits is possible. The meters themselves compare the result with the limit set and automatically qualify it as correct or incorrect. On completion of testing, the result can be stored in memory or printed. Sonel PATs have a unique function of storing single measurements (in manual mode), and not only automatic sequences. Meters for each measurement store the result, limit, date and parameters set. The data can be stored in the internal memory or on a memory stick. Barcode (read by an optional reader) can be assigned to every device tested. An optional printer allows printing the results, not only immediately after testing, but also those stored in memory.

As a standard, a set of necessary accessories is provided: measuring cables, probes, crocodile connectors, power cord, USB cable – all packaged in a handy case. Optional accessories include: printer, barcode reader, extension cord adapter or the adapters described in detail below, adapters for three-phase (high-current) sockets (see description below).

Professional software is also available. Sonel Reader application (included) allows full configuration of the meter and reading data from memory. The extended Sonel PAT software is also available for more demanding applications. This software allows holding a database of the devices tested, information on the upcoming tests, creating and printing brief or elaborate reports, creating reports complying with VDE 701-702, EN 61010, EN 60335, EN 60950, IEC 601.1. (described in the next section).



Fig. 30 PAT-805 with basic and additional accessories

9. Accessories for Sonel S.A. PAT-8xx meters

1) Adapters for industrial and 3-phase sockets.

Adapters for industrial sockets are intended for testing safety of devices supplied by 16 and 32 A sockets, if the maximum current drawn by the device tested does not exceed 16 A. They allow all measurements available in PAT-800/805 meters with the supply measurement socket.



Fig. 31. Adapters for 16A and 32A industrial sockets.

Adapters for 3-phase sockets are designed for testing safety of devices supplied by 16 and 32A supply sockets.

The non-switchable adapters for 3-phase sockets have permanently shorted L1, L2, L3 lines of a 3-phase socket and connected with the L line of a single phase plug.

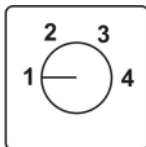

Fig. 32. Non-switchable adapters for 16A and 32A 3-phase sockets



Fig. 33. Switchable adapters for 16A and 32A 3-phase sockets

The switchable adapters for 3-phase sockets are provided with rotary switches to connect tested conductors, which allows, for example, location of insulation damage in an individual phase. The figure below presents possible settings.



- 1 - measuring socket L connected with L1
- 2 - measuring socket L connected with L2
- 3 - measuring socket L connected with L3
- 4 - measuring socket L connected with L1+L2+L3 (shorted)

Adapters for industrial and 3-phase sockets can be used for the following measurements:

- resistance of protective conductor R_{PE} (200mA, 10A, 25A);
- insulation resistance R_{ISO} (100V, 250V, 500V);
- slope leakage current I_{SUB} ;
- touch leakage current I_T .

Furthermore, the adapters for 16 A sockets can be used for measuring:

- PE leakage current;
- I_A differential leakage current;
- power and current drawn;
- automatic function with the above measurements.

Adapters can be used for $I_{max} = 16A$, $U_{max} = 265V$; their enclosure rating is IP40.

2) Adapters for testing IEC cables and extension cords.

The function for testing IEC cables, in addition to standard cables with IEC 60320-C13 plug, with special adapters, it is possible to test cables with IEC 60320-C5 plug and extension cords.



Fig. 34. IEC cable with IEC-60320-C13 plug on the left, and IEC-60320-C5 on the right.



Fig. 35. Adapter for testing IEC cables with IEC-60320-C5 plug

The adapter for testing IEC cables with IEC-60320-C5 plug allows testing cables with the “Mickey Mouse” connector, used for example in power supplies for laptops. It is possible to perform a full sequence of measurements including: testing insulation resistance of protective conductor, measurement of PE wire resistance (continuity), testing continuity of L and N conductors, and checking for short circuit.



Fig. 36. Adapters for testing extension cords.

Adapter for testing extension cords allows connection of a standard cord to the IEC test socket of a PAT meter.

2) Report printer and barcode reader.



Fig. 37. Report printer and barcode reader.

Report printer cooperates with the meter and SonelPAT software and allows printing the results and parameters of measurements directly from a PAT-8xx meter, both immediately after the measurement, and printing data stored in the meter memory. In addition to that, after connecting to a PC, it is possible to print measurement results sent to the SonelPAT software.

The barcode reader allows reading the device id number. This number can then be assigned to a proper cell containing the results in the meter memory and sent to the PC software. The barcode contains only the device id, no other information is coded.

The reader and printer are programmed to read codes in the CODE128 standard (only digits are used in PATs). PAT meter accepts only codes of 7 characters (e.g. 1234567), and all others are considered incorrect, so if a code of 6 or fewer characters is attempted, the reader will read it, but PAT will refuse to store it and, similarly, if the code has 8 or more characters, it will also be rejected.

10. Recording and documentation of tests with Sonel PAT software

Sonel PAT is the software for complete support in testing safety of electrical appliances. The software is intended for companies manufacturing power tools, performing type tests, service companies, and those using power tools and other equipment subject to tests (power plants, power distribution companies, water supply companies, mills, builders, hospitals etc.).

The software automatically collects data from the meter, evaluates the results, creates necessary documentation and manages the database of power tools and users. In addition to that, the program allows easy and quick configuration of meter parameters.

Basic program functions:

Automatic data download from the meter, transfer to the database and adding latest measurement results to the power tool history. The program supports PAT-800/805 meters.

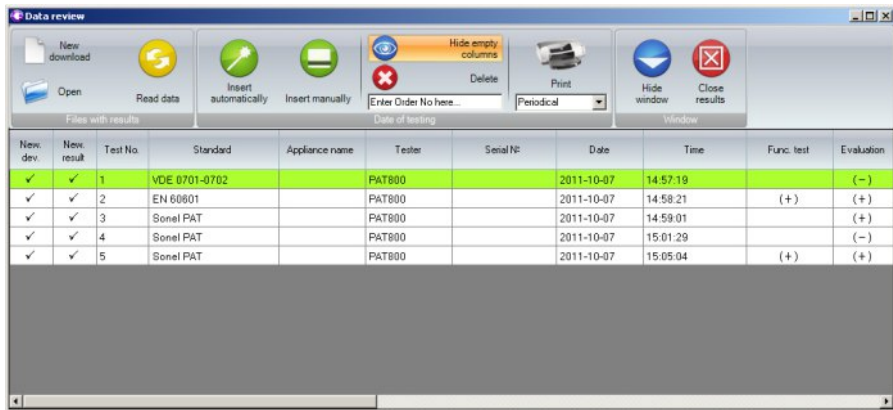

New dev.	New result	Test No.	Standard	Appliance name	Tester	Serial N:	Date	Time	Func. test	Evaluation
✓	✓	1	VDE 0701-0702		PAT800		2011-10-07	14:57:19		(-)
✓	✓	2	EN 60801		PAT800		2011-10-07	14:58:21	(+)	(+)
✓	✓	3	Sonel PAT		PAT800		2011-10-07	14:59:01		(+)
✓	✓	4	Sonel PAT		PAT800		2011-10-07	15:01:29		(-)
✓	✓	5	Sonel PAT		PAT800		2011-10-07	15:05:04	(+)	(+)

Fig. 38. Meter data reading window

The program automatically evaluates the results of the measurements, adds them to the schedule and graphically presents the status of testing each power tool. Information on the upcoming or missed test date is emailed to those responsible for the power tool.

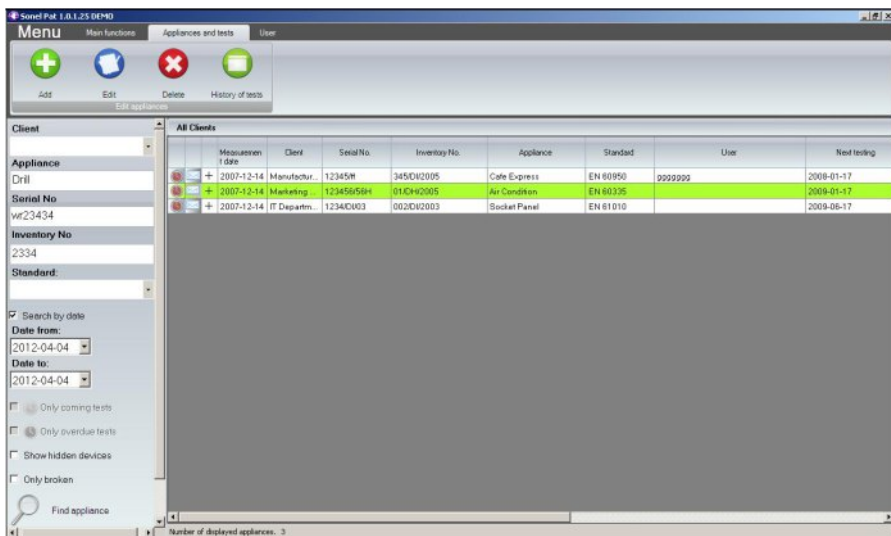

Fig. 39. Program main window displaying a list of equipment.

Sonel PAT offers extended functions for editing and searching users and power tools located in the database.

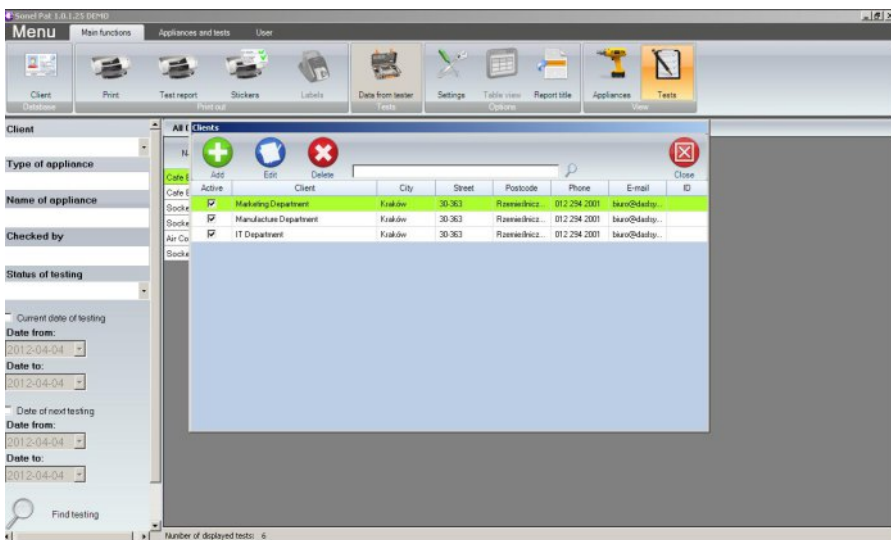
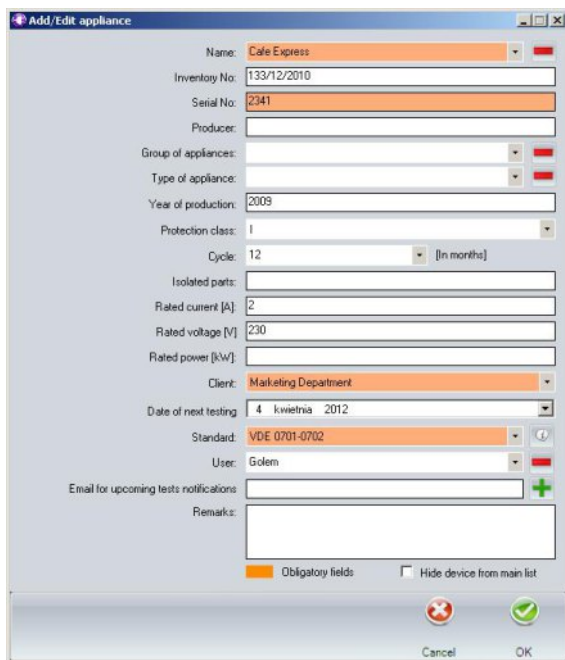

Fig. 40. Window displaying a list of companies (customers).



Add/Edit appliance

Name: Cale Express

Inventory No.: 133/12/2010

Serial No.: 2341

Producer:

Group of appliances:

Type of appliance:

Year of production: 2009

Protection class: 1

Cycle: 12 [In months]

Isolated parts:

Rated current [A]: 2

Rated voltage [V]: 230

Rated power [kW]:

Client: Marketing Department

Date of next testing: 4 kwietnia 2012

Standard: VDE 0701-0702

User: Golem

Email for upcoming tests notifications:

Remarks:

Obligatory fields Hide device from main list

Cancel OK

Fig. 41. Device (power tool) file.

Also test report names can be edited.

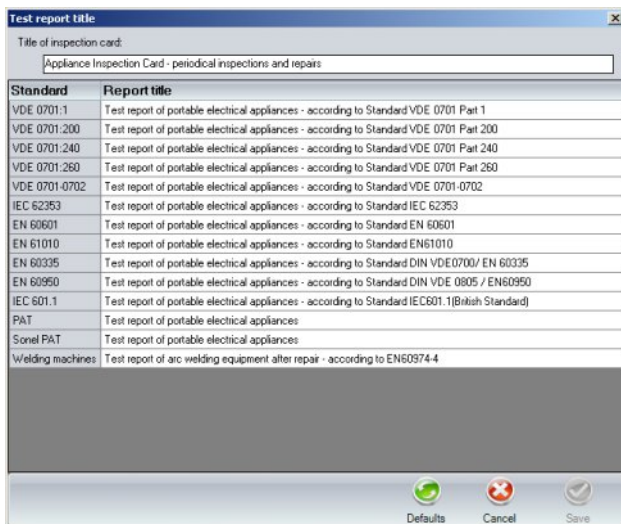

Test report title

Title of inspection card:
Appliance Inspection Card - periodical inspections and repairs

Standard	Report title
VDE 0701-1	Test report of portable electrical appliances - according to Standard VDE 0701 Part 1
VDE 0701-200	Test report of portable electrical appliances - according to Standard VDE 0701 Part 200
VDE 0701-240	Test report of portable electrical appliances - according to Standard VDE 0701 Part 240
VDE 0701-260	Test report of portable electrical appliances - according to Standard VDE 0701 Part 260
VDE 0701-0702	Test report of portable electrical appliances - according to Standard VDE 0701-0702
IEC 62353	Test report of portable electrical appliances - according to Standard IEC 62353
EN 60601	Test report of portable electrical appliances - according to Standard EN 60601
EN 61010	Test report of portable electrical appliances - according to Standard EN61010
EN 60335	Test report of portable electrical appliances - according to Standard DIN VDE 0700/ EN 60335
EN 60950	Test report of portable electrical appliances - according to Standard DIN VDE 0805 / EN60950
IEC 601.1	Test report of portable electrical appliances - according to Standard IEC601.1(British Standard)
PAT	Test report of portable electrical appliances
Sonel PAT	Test report of portable electrical appliances
Welding machines	Test report of arc welding equipment after repair - according to EN60974-4

Defaults Cancel Save

Fig. 42. Report name edit window.

Comprehensive configuration function allows maximum customisation of the program. Reports can be defined (constructed and described) by the user.

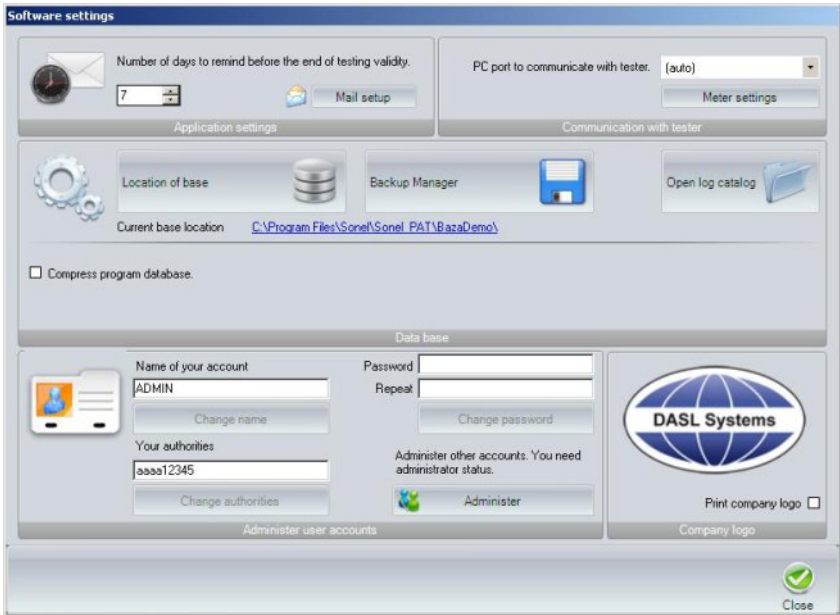

Fig. 43. Program configuration window.

Program printing functions:

The program prints reports according to the following standards: DIN VDE 701-702, EN 62353, IEC 60601, EN 61010, EN 60355, EN 60950, PN-88/E-08400. The reports can be prepared in various formats:







- Full report from one test

Test report for portable power tools, complying with VDE 0701-0702				
Order no:		Reason for measurement: Periodic test		
Customer: 345673456		Contractor:		
X Company Długa 15 56-343 Krakow 1234456678		DASLSystems ul. Rzemieślnicza 1 pok. 1 30-363 Krakow Poland		
Device:	DRILL	Manufacturer:	MAKITA	
Type:				
Serial no:	12233	Protection class/type :	1	
Year of manufacture:	2010			
ID:	Customer:	X Company		
Supervisor:				
Rated current (A):	Rated voltage (V):	Power rating (W):		
Results of inspection:				
Protections: no remarks (only for class 1 protection)			(x)	
Device enclosure and components			(x)	
Insulation			(x)	
Terminals, plugs and sockets			(x)	
Existing complete marking or correct type marking			(x)	
Inspection grade			(+)	
Mensuration		Result	Limit	OK.
Protection circuit resistance		0.22 Ω	<0.3 Ω	+
Differential resistance in protective conductor				x
Insulation resistance		>199.9 MΩ	>0.1 MΩ	+
Balancing current		0.02 mA	<0.05 mA	+
Probe current				x
Differential current		0.03 mA	<3.5 mA	+
Functional test:				
Maximum power drawn P _{MAX} [W]		x		
Power factor PF		x		
Maximum current drawn I _{MAX} [A]		x		
Energy consumption [kWh]		x		
Measurement time [hh:mm:ss]		x		
Voltage achieved during the voltage strength test		x		
Device tested for:				
Fire safety			(x)	
Electric shock risk			(x)	
Mechanical risk			(x)	
Functional test			(x)	
Test grade			(+)	
Complies with accident prevention rules ABG A3 (former VBG4):				
Cycle:	12 (mths)	Next test:	2011-10-26	
Meter used:				
Signatures:				
Tested by:				
ADMIN, rights aaa12345				
Date:	2010-10-26			
(+)	Test with POSITIVE result			
(-)	Test with NEGATIVE result			
(x)	Not tested			
Remarks:				

- test chart – history of tests with basic information on the device and its approval for use.

Power tool periodic tests and repair chart					
Device: Extension cord			Manufacturer: Acar		
Type: IT equipment			Protection class/device type: 1		
Serial no: 1234/DI/03			ID: 002/DI/2003		
Client: IT Department			Supervisor:		
Test no.	Test date	Remarks	Test no.	Test date	Remarks
1	2007-12-14		(+)	2008-01-17	ADMIN
2	2007-12-14		(+)	2008-01-17	ADMIN
3	2007-12-14		(+)	2009-06-17	ADMIN

Sonel PAT allows also printing stickers for the devices tested. This can be done with any printer, using the commonly available “window” self adhesive paper.

ID: --- Serial no: SN2348 Date: 2010-04-15 Next: 2010-08-15	 FAIL	ID: --- Serial no: 12345 Date: 2009-07-30 Next: 2009-11-30	 PASS	ID: --- Serial no: N8 Date: 2009-07-21 Next: 2009-11-21	 PASS	ID: 020/DI/2003 Serial no: 1234/DI/03 Date: 2007-12-14 Next: 2009-06-17	 PASS
ID: 01/DH/2005 Serial no: 123456/56H Date: 2007-12-14 Next: 2009-01-17	 PASS	ID: 345/DI/2005 Serial no: 12345/ff Date: 2007-12-14 Next: 2008-01-17	 PASS				

The program is updated with new functions, also, in specific cases, adjusted to individual needs of our clients. Telephone or online support is ensured to each user.

Current version of the program is available at www.sonel.pl.

Meter configuration functions:

Sonel PAT and free Sonel Reader, sold with the meter, allow configuration of the general data and parameters of individual measuring functions.

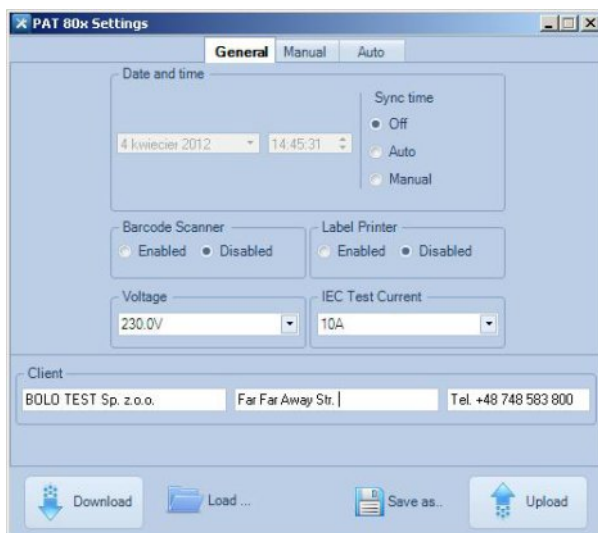

Fig. 44. General setting configuration window.

The user can input contact details which will be present on the reports printed directly from the meter (using an optional printer), set date, time and language of reports printed. In the Manual and Auto tabs, parameters of all measurements, both individual and included in autotest functions, can be configured.

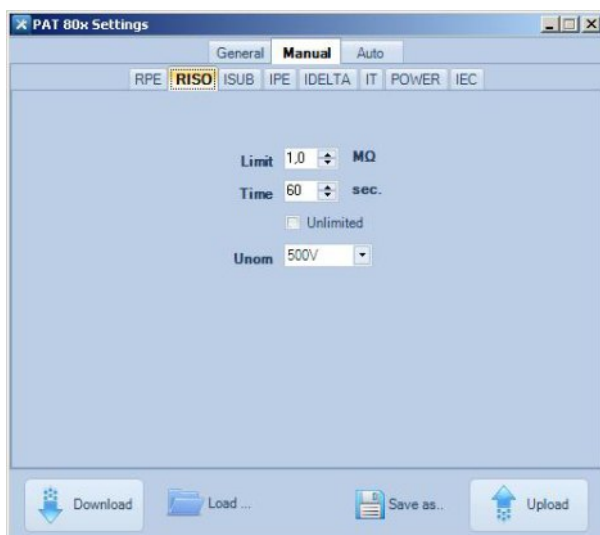

Fig. 45. Manual measurement configuration window.

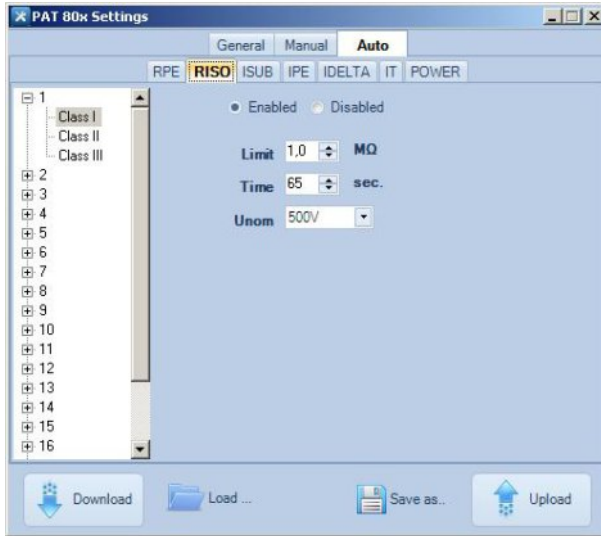

Fig. 46. Automatic measurement configuration window.

The program allows reading current meter configuration, saving meter settings in a file, downloading configuration from file, creating various configuration files, which is a simple method to prepare several configurations for various requirements, e.g. various clients and quick reprogramming of the meter according to the present needs.

11. Summary

Beyond all doubt, safe use of machinery and equipment is the responsibility of the owner (company owner, home user), therefore, to state that the equipment is safe, regular checks and tests should be performed, based on the approved standards.

It is also obvious that Sonel meters ensure precise measurements within their functional scope, taking into consideration the requirements of standards and regulations regarding tests of electrical devices. A compact case, legible display, access to all functions, simple operation and properly selected accessories make the 800 series PAT meters easy to transport and ensure intuitive operation of the equipment.

APPENDIX 1

Example of testing electrical appliances in an EU country with ambiguously defined norms (Poland).

Many individuals find it difficult to specify standards or legal acts related to periodic testing of the electrical devices. First of all, this applies to power tools, since the standard PN-88/E-08400/10:1988 Electric powered power tools. Safety of use. General requirements and tests, which for years had been the source of knowledge in this field and was cited in regulations as obligatory, in 2002 was withdrawn without replacement.

In 2003, PN-EN 60745-1:2003. Operating safety of electric-powered hand held tools. Part 1. General requirements was released, with a note that it superseded PN-88/E-08400/10:1988. However, the 60745-1 standard relates to type tests and testing of products made by tools manufacturers, without any mention of operating tests.

Note that not only power tools should be tested. Extension cords, office and kitchen equipment or production machines are equally prone to damage.

Information regarding operation, maintenance and tests can be found in the user's manual but, as the practice shows, all that can be found there is a brief note on the obligatory care and testing technical condition, or even no manual is enclosed at all. It will also be difficult to collect and read instructions for e.g. several dozen various devices from different manufacturers.

What then? There is a duty to follow the generally accepted technical rules as explicitly stated by the Construction Law. Therefore, for operating tests, PN-88/E-08400/10 should be considered as reference, since it was (some time before) approved by experts, verified and proved by many years of practice.

It is not a mistake to apply European standards, such as DIN VDE 0701 -0702 (VDE 0701 - 0702): 2008-06 Prüfung nach Instandsetzung, Änderung elektrischer Geräte - Wiederholungsprüfung elektrischer Geräte, especially because the measuring instruments for such measurements use, in most cases, test procedures developed based on the German or British standards.

Below, a list of provisions and titles of standards related to this publication is presented. These provisions govern the design, operation, maintenance of electrical equipment and authorisation to operate and perform periodic testing. The first, most important provision is an excerpt from the Labour Code, relating to the obligation to ensure safe operation and machinery and equipment.

It states explicitly that the owner (company owner, home user) is entirely responsible for safe use of machinery and equipment. In order to find out if the devices are safe, regular checks and tests have to be performed based on the approved subject-related standards.

Due to the size of the laws and regulation, below only fragments are presented which relate to the operation and testing of electrical appliances. Full wording of those laws is available at <http://isap.sejm.gov.pl>.

The Labour Code

Chapter IV. Machinery and other technical equipment

Article 215.

An employer shall ensure that the machines and other technical equipment used:

- 1) provide safe and healthy working conditions, in particular, protect the worker from injury, effects of hazardous chemicals, electric shock, excessive noise, and mechanical vibration, radiation and harmful and hazardous effects of other factors in the work environment,
- 2) take into account the principles of ergonomics.

Article 216.

§ 1.

An employer shall equip the machinery and other technical devices that do not meet the requirements of Article 215 with adequate security systems.

§ 2.

In the event that the security design is dependent on local conditions, is the responsibility of the employer to provide the device, machinery or other technical devices with the appropriate security measures.

Article 217.

It is not allowed to equip workplaces with machinery and other technical equipment, which does not conform to the requirements for the assessment of compliance provided in separate regulations.

Article 218.

Provisions of art. 215 and 217 shall apply to work tools accordingly.

Law of August 24, 1991, on fire protection (Journal of Laws 2002, no. 147, item 1299)

Article 6.

3. The obligation to meet fire protection requirements is also on the machinery, equipment and other product manufacturer, as well as on the purchaser of foreign licenses or machinery, devices and other imported products.
other product manufacturer, as well as on the purchaser of foreign licenses or machinery, devices and other imported products.

4. The above obligation also applies to the user of the machinery, devices or other products.

5. Starting the operation of a new, rebuilt or refurbished structure, object or land, machine, device or installation or any other product shall be allowed only when:

- 1) fire protection requirements have been complied with;
- 2) the fire fighting, rescue equipment and extinguishing media ensure effective protection from fire.

Law of July 7, 1994, Construction Law (Journal of Laws 2000, no. 106, item 1126 as amended)

Article 14.

1. Building license is granted in the following disciplines:

- 1) architecture;
- 2) building-construction;

- 2a) road;
- 2b) bridge;
- 2c) railway;
- 2d) demolition;
- 2e) telecom;
- 3) (waived);
- 4) installation, regarding heating, ventilation, gas, water supply and sewerage;
- 5) installation, regarding installation of electrical and power appliances (...)

Law of April 10, 1997, Energy Law (Journal of Laws no. 54 ite 348 as amended, last update of March 4, 2005, Journal of Laws no. 63 item 552)

Article 7a.

1. The equipment, systems and grids of entities applying for connection to the system shall meet technical and operating requirements ensuring:

- 1) operating safety of the gas, power or heat systems, and the related equipment or installations for generation and reception of heat, hereinafter referred to as the “heating system”;
- 2) protecting the gas, power or heat system against damage due to improper operation of the connected appliances, systems and grids;
- 3) protection of the connected equipment, systems and grids from damage in case of failures or imposing restrictions on the supply or drawing of gas fuel or energy;
- 4) assurance of quality parameters of gas fuel and electric power in the systems and grids at the point of connection;
- 5) meeting the environmental protection requirements stated by separate laws;
- 6) possibility to measure the parameters and values necessary to operate the grid and billing for the delivered fuel or energy.

2. The equipment, grids and systems, referred to in par. 1 shall also comply with the requirements set out in separate regulations, in particular: provisions of the Construction Law, fire and electric shock protection regulations, compliance assessment system, and in the regulations related to the technology of production of gas fuels or energy and type of the fuel used.

Article 51.

The design, manufacture, import, construction and operation of the equipment, systems and grids should ensure reasonable and economic use of fuels and energy, ensuring:

- 1) reliable interactions with the grid;
- 2) safety of the operators and surroundings after meeting the environmental protection requirements;
- 3) compliance with the requirements of separate provisions, especially those related to: the Construction Law, fire and electric shock protection regulations, technical supervision, protection of cultural assets, museums, Polish Standards introduced for obligatory use 18) or other regulations resulting from the technology of energy generation and the fuel used.

Article 54.

1. Persons operating grids, devices and installations referred to in the provisions of par. 6 shall

have qualifications acknowledged by certificates issued by qualification committees.

1a. Compliance with the qualification requirements are confirmed every five years.

1b. On finding that the equipment, grids and systems are not operated in line with the operating codes, at the request of the employer, labour inspector, the President of the Energy Regulatory Authority or other authority competent in the scope of regulation fuel and energy management, referred to in par. 21a, compliance with the qualification requirements shall be verified before expiry of the 5-year period.

2. It is prohibited to employ workers without qualifications as specified in par. 1, to operate grids, devices and systems referred to in the provisions of par. 6.

Article 56.

1. Financial penalty shall be imposed on those who:

....

10) do not keep the structures, systems and equipment in proper technical condition;

Regulation of the Minister of Economy dated September 17, 1999 on the occupational health and safety while working with electric power systems and equipment. (Journal of Laws no. 80 item 912)

§ 16.

1. The tools and protective equipment shall be stored in specified locations, in conditions ensuring mainstreaming their full functionality.

2. It is the employer's responsibility to decide on the methods for recording and testing the protective equipment.

3. The tools and protective equipment should undergo periodic testing in the scope provided by Polish Standards or the manufacturer's documentation.

4. The protective equipment referred to in par. 1 should be permanently marked with the id number, date of the next periodic test and designation mark.

5. It is prohibited to use equipment or tools which are not marked.

6. Supervisors shall periodically test the technical condition, methods of use, storage and recording the protective equipment and personal protection equipment.

§ 17.

1. The technical condition of the tools and protective equipment should be tested immediately before use.

2. The tools and protective equipment which is inoperable or whose the periodic testing validity has expired should be immediately withdrawn.

3. It is prohibited to use damaged or inoperable tools or protective devices.

Regulation of the Minister of Economy and Social Policy of April 28, 2003, on the detailed principles for verifying qualifications of persons operating devices, systems and grids (Journal of Laws no. 89, item 828)

Due to the size of the text, below only the scope of par. 1 is presented.

The Regulation specifies:

1) The types of works, workplaces and equipment, system and power grids which

- require special qualifications to be operated.
- 2) Scope of the required knowledge necessary to confirm the qualifications.
 - 3) Qualification procedure.
 - 4) Organisational units within which qualification committees are appointed and their appointment procedure.
 - 5) Fees charged for verifying the qualifications.
 - 6) Qualification certificate sample.

STANDARDS

PN-88/E-08400/10:1988 Electrically powered hand held tools. Operational tests.

PN-EN 60745-1:2003 Electrically powered hand held tools- Operating safety – Part 1. General requirements (superseded 02 PN-88/E-08400).

PN-EN 60745-1:2003 Operating safety of electrically powered hand held tools. Part 1: General requirements.

PN-EN 60950:2002 Safety of IT equipment.

PN-EN 60990:2002 Methods for measuring the touch current and protective wire current.

DIN VDE 0701-0702 (VDE 0701-0702): 2008-06 Prüfung nach Instandsetzung, Änderung elektrischer Geräte – Wiederholungsprüfung elektrischer Geräte.

DIN VDE 0751:2001 Wiederholungsprüfungen und Prüfungen vor der Inbetriebnahme von medizinischen elektrischen Geräten oder Systemen.

PN-EN 62353 Medical electrical equipment - Periodic inspection and testing after repair of medical electrical equipment.

IEC 60601 Medical electrical equipment.

PN-EN 60974-4: 2009 Arc welding equipment. Part 4: Inspection and testing in operation.

Position of the National Labour Inspectorate in Krakow and the Chief Labour Inspectorate in Warsaw on testing safety of power tools (in the following pages).

Attn:

Mr. Grzegorz Dąbrowski

DASL SYSTEMS

ul. Rzemieślnicza 1

30 - 363 KRAKOW

Referring to the letter of 07.22.2009 r, and raised questions about the duty to determine the frequency of testing hand-held power tools and the necessary documentation we kindly inform you that:

Re 1. The National Labour Inspectorate has no information on the development of the PN standard or the rule of law devoted to periodic testing of power tools. In this case, I propose you to contact the Polish Committee for Standardization and the Ministry of Economy.

Re 2. In the national regulations and standards there is no applicable technical norm stating the frequency and extent of the checks while operating power tools. The standard PN-E-084G0-10:1968 Electrically powered hand held tools. Operating checks was repealed by the Polish Committee for Standardization.

Re 3. According to valid legal status in the country, electrically powered tools must be operated and subjected to periodic verification in accordance with the provisions of the user's manual drawn up by the manufacturer of the device. This obligation is laid down in § 51 paragraph. 2 of the Regulation of the Minister of Labour and Social Policy of 26.09.1997, on the general safety and health (Journal of Laws of 2003, No. 169, item. In 1650, as amended), and for electrically powered hand held tools operated in site conditions, the duty to perform inspections in accordance with instructions developed by the manufacturer is specified in the §105 of the Regulation of the Minister of Infrastructure of 06.02.2003 on occupational health and safety during construction works (Journal of Laws of 2003, no. 47, item. 401).

This means that any information concerning the requirements for the safe operation and maintenance of power tools should be sought at the specific operating instructions, which manufacturers of machinery and electric hand tools are obliged to develop.

Re 4. In Poland, there is a rule for testing specified under par. 3. Provisions of the VDE 701, VDE 702 or British Standards can be applied unless they are contrary to the requirements set out in par. 3.

Re 5. According to the requirement set out in § 51 paragraph. 1 of the Regulation of the Minister of Labour and Social Policy of 26.09.1997, on the general safety and health (Journal of Laws of 2003, No. 169, item. In 1650, as amended), the primary responsibility of each user is to maintain machinery and equipment in condition which poses no threat to the operators during their lifetime, which means that the user of electrically-driven hand tools can shape the rules for

the operation and control of the above group of devices based on any technical conditions, i.e., for example, based on the mentioned Polish Standard PN-E-08400-10:1988. Electrically powered hand held tools. Operating checks”.

Safety requirements for operation of portable electrically powered hand-held or hand led machinery are set out in the Regulation of the Minister of Economy of 21.08.2007 on essential requirements for electrical equipment (Journal of Laws no. 155 item 1089) and the Polish Standards: PN-EN 60745 -1: 2003 "Operating safety of electrically powered hand held tools. Part 1. General requirements”;

- PN-EN 60745-2-1:2006 "Operating safety of electrically powered hand held tools. Particular requirements for drills”
- PN-EN 60745-2-2:2007 "Operating safety of electrically powered hand held tools. Particular requirements for drill drivers and impact wrenches”
- PN-EN 50144-2-3:2005 "Operating safety of electrically powered hand held tools. Particular requirements for grinders, disk type sanders and polishing machines”.

The labour inspector, in relation to the consumers of electricity, supplied with voltage up to 1 kV AC, shall validate the use in accordance with the provisions arising from the manual of the device, i.e. the labour inspector can only act within the scope of the above-cited law.

Re 6. The documents to confirm measurements of electric shock protection of power tools are the measurement reports. Please also note that the measurements should be carried out by persons having proper SEP (Association of Polish Electrical Engineers) license.

Re 7. The above statements refer to carrying out the periodic testing of all electric energy-consuming units, supplied with the voltage up to 1 kV AC, production, IT equipment, household appliances etc. The acceptance and periodical testing of the electrical system supplying the receivers should be carried out according to the provision of the Polish standards PN-HD 60364-6 Low voltage electrical systems. Part 6: Testing.

P. O. DYREKTORA
Departamentu Napięć i Kontroli
[Signature]
dr Grzegorz Tyjak

1S-197-4560-777/09

DASL, Systems
ul. Rzemieślnicza 1
30-363 Kraków

subject: letter of July 20, 2009

In reply to your above letter and with regard to the conversation of August 6, 2009, please note the following:

1. The above issue is regulated by the following acts:

- Act of 26 June 1974. Labour Code (Journal. Laws of 1998 No 21, item 94, as amended).
- Regulation of the Minister of Labour and Social Policy of 26.09.1997, on the general safety and health (Journal of Laws of 2003, No. 169, item. In 1650, as amended);
- PN-EN 60745-1:2009 Electrically powered hand held tools. Operating safety. Part 1. General requirements.
- PN-EN 60745-1:2009 Electrically powered hand held tools. Operating safety. Part 2-1. Requirements for **drills and impact drills**.
- PN-EN 60745-2-1:2006/A11:2007 Electrically powered hand held tools. Operating safety. Part 2-1. Detailed requirements for **drills and impact drills**.
- PN-EN 60745-2:2007 Electrically powered hand held tools. Operating safety. Part 2-2. Particular requirements for **drill drivers and impact wrenches**.
- PN-EN 60745-2-2:2007/A11:2007 Electrically powered hand held tools. Operating safety. Part 2-2. Particular requirements for **drill drivers and impact wrenches**.
- PN-EN 60745-2-4:2006 Electrically powered hand held tools. Operating safety. Part 2-4. Particular requirements for **non-disc grinders and polishing machines**.
- PN-EN 60745-2-4:2006/A11:2007. Particular requirements for **non-disc grinders and polishing machines**.
- PN-EN 60745-5:2009 Electrically powered hand held tools. Operating safety. Part 2-5. Particular requirements for **disc saws**.
- PN-EN 60745-5:2007 Electrically powered hand held tools. Operating safety. Part 2-5. Particular requirements for **disc saws**.
- PN-EN 60745-6:2009 Electrically powered hand held tools. Operating safety. Part 2-6. Particular requirements for **hammers**.
- PN-EN 60745-2-6:2006/A11:2006 Electrically powered hand held tools. Operating safety. Part 2-6. Particular requirements for **hammers**.
- PN-EN 60745-2-6:2006/A11:2007 Electrically powered hand held tools. Operating

- safety. Part 2-6. Particular requirements for **hammers**.
- PN-EN 60745-8:2007 Electrically powered hand held tools. Operating safety. Part 2-8. Particular requirements for **plate shears and cutters**.
 - PN-EN 60745-2-8:2007/A11:2007 Electrically powered hand held tools. Operating safety. Part 2-8. Particular requirements for **plate shears and cutters**.
 - PN-EN 60745-9:2004 Electrically powered hand held tools. Operating safety. Part 2-9. Particular requirements for **threading machines**.
 - PN-EN 60745-2-9:2004/A11:1 Electrically powered hand held tools. Operating safety. Part 2-9. Particular requirements for **threading machines**.
 - PN-EN 60745-2-9:2004/A11:2007 Electrically powered hand held tools. Operating safety. Part 2-9. Particular requirements for **threading machines**.
 - PN-EN 60745-11:2007 Electrically powered hand held tools. Operating safety. Part 2-11. Particular requirements for **blade saws (angular and straight)**.
 - PN-EN 60745-2-11:2004/A11:2007 Electrically powered hand held tools. Operating safety. Part 2-11. Particular requirements for **blade saws (angular and straight)**.
 - PN-EN 60745-12:2004 Electrically powered hand held tools. Operating safety. Part 2-12. Particular requirements for **concrete vibrators**.
 - PN-EN 60745-13:2007 Electrically powered hand held tools. Operating safety. Part 2-13. Particular requirements for **chain saws**.
 - PN-EN 60745-14:2009 Electrically powered hand held tools. Operating safety. Part 2-14.
 - PN-EN 60745-2-14:2006/A1:2007 Electrically powered hand held tools. Operating safety. Part 2-14. Particular requirements for **planners**.
 - PN-EN 60745-2-14:2006/A11:2007 Electrically powered hand held tools. Operating safety. Part 2-14. Particular requirements for **planners**.
 - PN-EN 60745-15:2008 Electrically powered hand held tools. Operating safety. Part 2-15. Particular requirements for **hedge trimmers**.
 - PN-EN 60745-17:2007 Electrically powered hand held tools. Operating safety. Part 2-17. Particular requirements for **routers and laminate trimmers**.
 - PN-EN 60745-2-17:2007/A11:2007 Electrically powered hand held tools. Operating safety. Part 2-17.
 - PN-EN 60745-18:2005 Electrically powered hand held tools. Operating safety. Part 2-18. Particular requirements for **strapping machines**.
 - PN-EN 60745-2-18:2005/A11:2008 Electrically powered hand held tools. Operating safety. Part 2-18. Particular requirements for **strapping machines**.
 - PN-EN 60745-2-18:2005/A11:2006 Electrically powered hand held tools. Operating safety. Part 2-18. Particular requirements for **strapping machines**.
 - PN-EN 60745 60745-2-18:2005/AC:2008 Electrically powered hand held tools. Operating safety. Part 2-18. Particular requirements for **strapping machines**.
 - PN-EN 60745-2-18:2005/A11:2008 Electrically powered hand held tools. Operating safety. Part 2-18. Particular requirements for **strapping machines**.
 - PN-EN 60745-2-18:2005/A11:2007 Electrically powered hand held tools. Operating safety. Part 2-18. Particular requirements for **strapping machines**.
 - PN-EN 60745-19:2005 Electrically powered hand held tools. Operating safety. Part 2-19. Particular requirements for **jointers**.
 - PN-EN 60745-2-19:2005/A11:2007 Electrically powered hand held tools. Operating safety. Part 2-19. Particular requirements for **jointers**.

- PN-EN 60745-20:2007 Electrically powered hand held tools. Operating safety. Part 2-20. Particular requirements for **band saws**.
- PN-EN 60745-2-20:2006/A11:2007 Electrically powered hand held tools. Operating safety. Part 2-20. Particular requirements for **band saws**.
- PN-EN 60745-21:2007 Electrically powered hand held tools. Operating safety. Part 2-21. Particular requirements for **drain cleaners**.

2. As a rule, the provisions of PN 88 E 08400 10 shall be adopted.



Sonel offers broad range of training:

MPI-520/SONEL PE5: Operating, measurements with multi-function MPI-520 meter, and issuing test reports with SONEL PE5 software.

MPI-508 and SONEL PE5 software: Operating, measurements with multi-function MPI-511/ MPI-508 meters, and issuing test reports with SONEL PE5 software.

MRU 200 / SONEL PE5 software: Operating, measurements with earthing resistance and ground resistivity MRU-200 meter, and issuing test reports with SONEL PE5 software.

KT-384, KT-160, KT-160A, KT-150, KT-140 thermovision cameras: Operating, measurements with thermovision cameras and issuing reports with Sonel ThermoAnalyze software.

PQM-701 and SonelAnalysis software: Operating, recording with PQM-701 power supply quality analyser and issuing analysis reports with SonelAnaliza software.

PAT-805, PAT-800 and SonelPAT software: Operating, measurements with PAT-800, PAT-805 electrical safety meters, and issuing reports with the SonelPAT software.

Measuring techniques: Cycle of training courses on measuring techniques, regulations, standard and operating SONEL meters.



SONEL S.A.

ul. Wokulskiego 11, 58-100 Świdnica, Poland

Sales:

Phone +48 74 85 83 860

Fax +48 74 85 83 809

e-mail: export@sonel.pl

www.en.sonel.pl